



STERILCONTAINER UND  
AEMP ZUBEHÖR

STERILE CONTAINERS AND  
RUMED ACCESSORIES





ASANUS vernetzt, berät und steuert Prozesse für Steril- und Medikalprodukte in Krankenhäusern und anderen Gesundheitseinrichtungen.

We link, advise and control processes for sterile and medical products in hospitals and other healthcare facilities.



Innerhalb von Aufbereitungs- und Verbrauchsabteilungen (OPs, AEMPs, Laboren, etc.) werden die Materialien auf Verfügbarkeit und deren Bedarf, auch mit RFID Chip Technologie, automatisch gesteuert und überwacht.

Within treatment and consumption departments (ORs, RUMEDs, labs, etc.) the material is controlled and supervised automatically on availability and demand, also with RFID Chip technology.



Wir entwickeln und produzieren ein Komplettdprogramm hochwertiger chirurgischer Instrumente mit eigenem ASANUS-Standard. Dieser geht in Sachen Präzision weit über den DIN-Standard hinaus.

We develop and manufacture a complete program of finest surgical instruments with the own ASANUS-standard, which is much more precise than the known DIN-standard.



## Die digitalisierte Automatisierung Ihrer Prozesse für all Ihre Klinikmaterialien in Industriestandard 4.0.

Die ARIS Technologie basiert auf einem an das Medizinprodukt angebrachten RFID Chip. ASANUS bringt an Ihre chirurgischen Instrumente und alle Medizinprodukte einen RFID Chip auf. Diese mit RFID Chips versehenen Produkte können dann transparent überwacht werden. Dadurch erhalten Sie wertvolle Informationen über den Einsatz, Verlust und die Wirtschaftlichkeit Ihrer im Einsatz befindlichen Produkte.

Auf Wunsch können wir Ihnen alle ASANUS Instrumente mit einem RFID Chip ausliefern.

In Kombination mit unserer BarCon Software für Instrumentenmanagement und Sterilgut erlangen Sie durch ARIS Einzelrückverfolgbarkeit und eine besonders hohe Patientensicherheit, sowie Informationen über die ständige Verfügbarkeit Ihres Instrumentariums. Es wird dafür gesorgt, dass Ihre Instrumentensiebe zukünftig immer vollständig und einsatzbereit sind. Durch die elektronische Zählung von Instrumenten bietet ARIS eine hohe Sicherheit im OP Saal. In Sekundenschnelle haben Sie ganze Siebe komplett registriert und gezählt. Alle mit RFID Chip gekennzeichneten Instrumente Ihrer einzelnen Siebe können im Pulk auf einmal registriert und ausgelesen werden.

Mit ARIS stimmen Ihre Lager- und Inventurbestände in Echtzeit. Dies ermöglicht unser ARIS System durch eine elektronische Überwachung und Verbuchung Ihrer Nachlegelager zusammen mit der BarCon Software.

Zudem bieten wir Ihnen eine Automatisierung Ihrer AEMP Prozesse. Sicher, schnell und lückenlos werden Ihre Instrumentensiebe vom Reinigungs- und Desinfektions-Prozess bis hin zur Sterilgutfreigabe gesteuert und registriert. Die Dokumentation ist ein Zusatzergebnis in Echtzeit, welches zu Ihrer gesetzlichen Rechtssicherheit dient.

## The digitalized automation of your processes for all your clinic materials in line with the industrial standard 4.0.

The ARIS technology is based on an RFID chip attached to the medical product. ASANUS attaches an RFID chip to your surgical instruments and all medical products. This results in transparency when monitoring these products fitted with an RFID chip, providing you with valuable information about the use, loss and economy of your products in use.

If requested, we can supply all ASANUS instruments with an RFID chip.

In combination with our BarCon Software for instrument management and sterile goods, you can, with ARIS, have individual traceability and very high patient safety, as well as information about the constant availability of your instruments. It ensures that your instrument trays will always be complete and ready to use in future. By counting instruments electronically, ARIS provides a high level of safety in the operating theatre. Within seconds whole trays can be completely registered and counted. All the instruments with an RFID chip in your individual trays can be registered and selected simultaneously at one go.

Using ARIS, your stock and inventory figures are correct in real time. Our ARIS system makes this possible through electronic monitoring and registration of your re-filled stock together with your BarCon Software.

Additionally, we offer automation of Sterile Services processes. Your instrument trays will be controlled and registered safely, swiftly and without any gaps right from the cleaning and disinfection process through to sterile goods release. The documentation is an additional result in real time providing you with legal certainty.

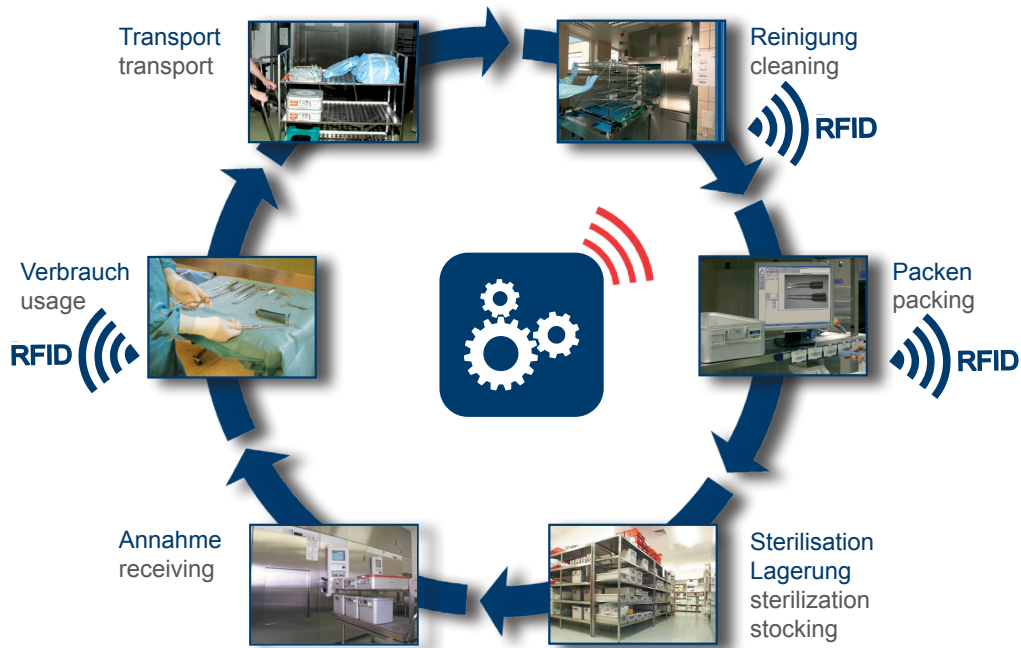

**Das Fundament für Ihr Datcockpit aller medizinischen Materialprozesse in Ihrer Klinik.**

Mit der ASANUS Software BarCon sind Sie in jeder Hinsicht auf der sicheren Seite bei Ihren Materialprozessen. Die BarCon Software ist die Grundlage für unser ARIS RFID Chip System und bietet Ihnen ein Informationscockpit für alle Ihre wesentlichen und wichtigen Prozessinformationen rund um Ihr Sterilgut und Ihre gesamten Medikalprodukte. Die Prozesse beinhalten alle Schritte von der Lieferung bis hin zum Einsatz im OP und anderen Nutzungsorten. Unsere Technologie ist das einzigartige Komplettsystem weltweit.

Die ausgereifte Software fand ihren Beginn im Jahre 1999 und entwickelt sich seitdem ständig weiter. Dadurch verbessern wir ständig Ihr komplettes Instrumentenmanagement und die Chargendokumentation. Die BarCon Software bietet Ihnen noch viel mehr, beispielsweise ein ganzheitliches Materialprozessmanagement wie „Fallwagen“ und viele weitere Eigenschaften.

Für weitere Detailinformationen zu unserer BarCon Software, scannen Sie bitte den neben aufgeführten QR-Code ein.

**The basis for your data cockpit of all medical material processes in your clinic.**



If you use the ASANUS Software BarCon, you are on the safe side regarding your material processes in every respect. The BarCon software is the basis of our ARIS RFID chip system and provides you with an information cockpit for all your essential and important process information all about your sterile goods and all your material products. The processes encompass all steps from delivery to use in the operating theatre and other places of use. Our technology is the unparalleled complete system worldwide.

The sophisticated software was launched in 1999 and has been constantly developed and upgraded further since. We can therefore constantly improve your complete instrument management and batch documentation. The BarCon software offers you even more, for example an integrated material process management such as “case cart” and many other features.

For more detailed information on our BarCon Software, please scan the QR code in the bottom right corner.



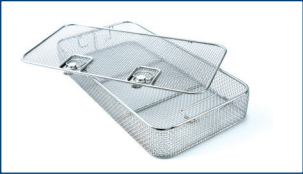
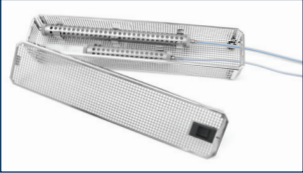
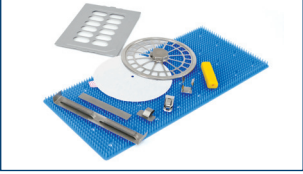

		ab Seite from page
	<b>Sterilcontainer System</b> sterile container system	3
	<b>Basic Plus Sterilcontainer System</b> <b>basic plus</b> sterile container system	9
	<b>Basic Sterilcontainer System</b> <b>basic</b> sterile container system	13
	<b>Multi Flex Sterilcontainer System</b> <b>multi flex</b> sterile container system	25
	<b>Dental, Mini und Spezial Container</b> <b>dental, mini and special</b> container	33
	<b>Siebkörbe</b> wire baskets	49
	<b>Waschrohrsystem</b> washer tube system	81
	<b>Zubehör</b> accessories	85
	<b>Hardware und Zubehör für Software</b> hardware and accessories for software	115
	<b>Artikelnummern Index</b> item number index	131







## Sterilcontainer System

### sterile container system

Basic Plus Sterilcontainer System.....	9
Basic Sterilcontainer System.....	13
Multi Flex Sterilcontainer System .....	25
Dental, Mini und Spezial Container .....	33

basic plus sterile container system.....	9
basic sterile container system .....	13
multi flex sterile container system.....	25
dental, mini and special container .....	33



Smart Tracking mit RFID Chip  
automatisches Beladen von Waschmaschinen  
und Sterilisationsgeräten

smart tracking via RFID Chip  
automatic loading of washers und sterilizers











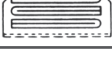

- spezielles Deckeldesign für Stapelbarkeit
- korrosionsbeständiger Deckel und Boden aus 2 mm hochwertigem Spezial-Aluminium
- abgedichtete Filterhalter mit zwei Federn im Inne und sicheren Wechsel der Filter durch festen Sitz auf der Oberfläche
- Der Verriegelungsmechanismus sorgt für eine bessere Griffbarkeit mit seiner flexiblen Konstruktionsstruktur, einschließlich zwei Schalen innen und "einstufiger" Bewegung.
- Der wärmeempfindliche modulare automatische Verriegelungsmechanismus bietet ein sichereres Ergebnis für den Sterilisationsprozess.
- Kennzeichnungsschilder können mit 18 - 24 Buchstaben markiert werden.
- Breite, spezielle Konstruktion. Silikonbeschichtete Griffe ermöglichen eine einfache und sichere Handhabung des Behälters und verhindern Handverletzungen.
- Die Frontplatten an beiden Seiten des Containers sind aus einem Stück gefertigt.
- special lid design for stackability
- corrosion-resistant lid and bottom made of 2 mm high quality special aluminium
- sealed filter retainers with two springs inside and safe replacement of the filter by tight fit on the surface
- The locking mechanism provides a better grip with its flexible construction structure, including 2 cups inside and "single-stage" movement.
- The heat-sensitive modular automatic locking mechanism provides a safer result for the sterilization process.
- Identification labels can be marked with up to 18 - 24 letters.
- Wide, special construction. Silicone coated handles allow easy and safe handling of the container and avoid hand injuries.
- The front panels on both sides of the container are made in one piece.

Eignung der Sterilisierbehälter für verschiedene Dampfsterilisationsverfahren <sup>1)</sup>, gemäß DIN 58953 Teil 9  
suitability of our sterile containers for steam sterilization procedure <sup>1)</sup> as per DIN 58953 part 9

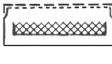
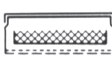
Art der Packung  
packing

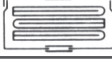
Anforderung nach DIN 58946, Teil 1  
steam sterilization procedure according to DIN 58946, part 1

Beschreibung description	symbolische Darstellung und Packlage illustration and packing system	Gravitationsverfahren gravitation procedure	Vor-Vacuumverfahren pre-vacuum procedure	Fraktioniertes Vacuumverfahren fractional vacuum procedure	Fraktioniertes Strömungsverfahren fractional flow procedure	Dampfinjektionsverfahren steam injection procedure
-----------------------------	---	--	---	---	--	---

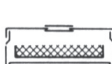
mit Filter with filters	Textilien in Sterilisierbehälter mit Filter in Deckel und Boden textiles in sterilization container with filter in lid and bottom		+	+	+	+	+	
			0	0	+	+	+	
	Textilien in Sterilisierbehälter mit Filter in Deckel, Boden nicht perforiert textiles in sterilization container with filter in lid, bottom not perforated		-	-	+	+	+	
			-	-	+	+	0	
	Textilien in Sterilisierbehälter mit Filter in Boden, Deckel nicht perforiert textiles in sterilization container with filter in bottom, lid not perforated		0	+	+	+	+	
			-	0	+	+	+	
	Instrumente auf Sterilisiersiebschalen in Sterilisierbehälter mit Filter in Deckel und Boden instruments in wire basket in sterilization container with filter in lid and bottom		+ <sup>3)</sup>	+	+	+	+	
	Instrumente auf Sterilisiersiebschalen in Sterilisierbehälter mit Filter in Deckel, Boden nicht perforiert instruments in wire basket in sterilization container with filter in lid, bottom not perforated		-	+ <sup>2)</sup>	+ <sup>2)</sup>	+ <sup>2)</sup>	+ <sup>2)</sup>	
	Instrumente auf Sterilisiersiebschalen in Sterilisierbehälter mit Filter in Boden, Deckel nicht perforiert instruments in wire basket in sterilization container with filter in bottom, lid not perforated		0	+	+	+	+	
	mit Ventil with valves	Textilien in Sterilisierbehälter mit Ventilen in Deckel und Boden textiles in sterilization container with valves in lid and bottom		-	0	+	+	0
				-	-	+	+	0
		Textilien in Sterilisierbehälter mit Ventilen im Deckel, kein Ventil am Boden textiles in sterilization container with valves in lid, no valves in bottom		-	-	+	+	-
			-	-	+	+	-	
Instrumente auf Sterilisiersiebschalen in Sterilisierbehälter mit Ventil in Deckel und Boden instruments in wire basket in sterilization container with valve in lid and bottom			-	+ <sup>2)</sup>	+ <sup>2)</sup>	+ <sup>2)</sup>	+ <sup>2)</sup>	
Instrumente auf Sterilisiersiebschalen in Sterilisierbehälter mit Ventil in Deckel, Boden nicht perforiert instruments in wire basket in sterilization container with valve in lid, bottom not perforated			-	+ <sup>2)</sup>	+ <sup>2)</sup>	+ <sup>2)</sup>	+ <sup>2)</sup>	

Zeichenerklärung: + anwendbar - nicht anwendbar o bedingt anwendbar  
explanation of symbols: + applicable - not applicable o limited applicable

<sup>1)</sup> Um Fehler bei Service, Bedienung und/oder beim Beladen des Sterilisators zu vermeiden, beachten Sie bitte Tabelle 1 für die richtige oder falsche Kombination von Sterilisationsbehältern für standardisierte Dampfsterilisationsverfahren.  
<sup>2)</sup> Nur Sterilisationsbehälter, die eine Verdampfung oder Ableitung von Kondensat gewährleisten, sind oben geeignet.  
<sup>3)</sup> Gravitationsverfahren ohne Trocknungsvorrichtung garantieren keinen ausreichenden Nachrocknungseffekt.  
<sup>1)</sup> In order to avoid mistakes regarding service, operation and/or when loading the sterilizer, please refer to tabel 1 for correct or wrong combination of sterilization containers for standardized steam sterilization procedures.  
<sup>2)</sup> Only sterilization containers guaranteeing evaporation or discharge of condensate are suitable above.  
<sup>3)</sup> Gravitation procedures having no drying device do not guarantee a sufficient after-drying effect.

## Qualität, Vorteile und Nutzen quality, features and benefits



**Auto Lock Mechanismus (modular)**  
Ein wärmeempfindliches automatisches Schließsystem, um die Sterilisationskontrolle in der AEMP zu erleichtern.  
Auto Lock Mechanism (Modular)  
A heat-sensitive automatic locking system in order to facilitate the sterilization control in CSSD.



Der Silikongriff ist in sechs verschiedenen Farben erhältlich und vom Benutzer abnehmbar.  
The silicone handles are available in six different colours and can be removed by the user.



Die Verriegelungen sind um 180° drehbar und können in jeder Position gesichert werden.  
Locking flaps are movable 180° on a pivot and can be secured in any position.



**Kunststoff-Sicherheitssiegel** schützen den Container vor unbefugtem Öffnen. Sie brechen beim Anheben der Verschlussklappe automatisch auf.  
Plastic security seals keep the container safe from unauthorized opening. They automatically break up when the locking flap is lifted.



Mit Hilfe der Verriegelungsfunktion ermöglichen die Filterhalterungen einen schnellen Filterwechsel.  
By means of the locking function, the holders of the filters enable a quick filter change.



Der Mechanismus des Schlosses kann als Deckelgriff verwendet werden.  
The locking mechanism can be used as a lid handle.



Die Container können sicher gestapelt werden.  
The containers can be safely stacked.

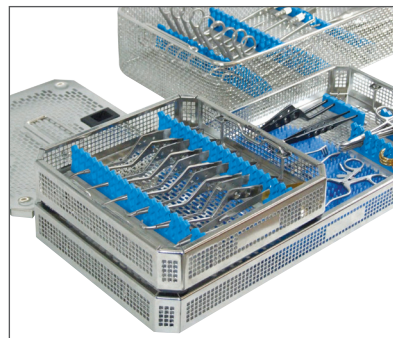

Silikonfixierungssysteme schützen die Instrumente sowohl bei der Sterilisation als auch beim Transport.  
Silicone fixation systems fix and protect the instruments during sterilization and transportation.



Farbige Aluminium-Etiketten zeigen die Beschreibung und die Abteilung des sterilen Gegenstands an und können leicht in die Schlitze geschoben werden.  
Coloured aluminium labels indicate the description and department of the sterile item and can be easily slid into the slots.



Im Inneren des Deckels angeordnete Silikondichtungen sorgen für eine sichere Abdichtung des Behälters.  
Silicone gaskets inside of the lid ensure a secure seal of the container.



Multi Flex Containersysteme sind mit einem integrierten Sicherheitsdeckel aus Aluminium oder optional aus PPS erhältlich.  
Multi flex container systems are available with an integrated safety lid which is made of aluminium or optionally of PPS.



Dieses Behältermodell kann mit PTFE-Filter, mechanischem Ventil oder Biostop-System ohne zusätzliche Deckelkosten verwendet werden.  
This container model can be used with PTFE filter, mechanical valve or biostop system without any extra lid cost.



Das PTFE-Filtersystem von Multi Flex wird mit einem Teflonfilter mit 2000 Zyklen verwendet, der vom Benutzer leicht gewechselt werden kann.  
Multi flex PTFE filtering system is used with a 2000 cycles teflon filter which can be easily changed by the user.



Das Multi Flex-Ventilfiltersystem ist mit mechanischen Ventilen ausgestattet, die das Öffnen, Reinigen und Wechseln der Ersatzteile vereinfachen. Der einwandfreie Lauf des Mechanismus kann einfach über den One-Touch-Kontrollstift in der Mitte des Systems überprüft werden.  
Multi flex valve filtering system runs with mechanical valves inside which easily opening, cleaning and change of the spares. The proper running of the mechanism can be easily checked by a one touch control pin at the center of the system.



Das Multi-Flex-Biostop-Mechanismus-Filtersystem ist optional aus PPS oder Aluminium erhältlich. Der Biostop-Mechanismus ist ein wartungsfreies Filtersystem, das eine lebenslange sichere Nutzung bietet und Sicherheit nach dem Pasteur-Schwanenhalskolben-Prinzip. Der labyrinthartige Luftkanal stoppt Mikroorganismen und Keime und benötigt keine Verbrauchsmaterialien.  
The multi flex biostop mechanism filter system is optionally available in PPS or aluminium. The biostop mechanism is a maintenance-free filtration system which provides lifetime use and protection according to Pasteur's swan neck flask principle. The labyrinthine air channel stops microorganisms and germs and requires no consumables.



Produkt-Kennzeichnung  
product identification

**CT5774PS**

- 
- ASANUS Artikelnummer, ASANUS article number
  - Multi Flex Filtersystem, multi flex filtering system
    - P - PTFE, PTFE
    - V - Valve, valve
    - B - Biostop, biostop
    - A - Biostop Aluminium, biostop aluminium
  - Farbgebung der Containerdeckel, colour of container lid
    - S - grau, grey
    - Y - gelb, yellow
    - G - grün, green
    - B - blau, blue
    - R - rot, red
    - A - schwarz, black



## Basic Plus Sterilcontainer System

### basic plus sterile container system

Basic Plus 1/2 Sterilcontainer.....	10
Basic Plus 3/4 Sterilcontainer.....	11
Basic Plus 1/1 Sterilcontainer.....	12

basic plus 1/2 sterile container .....	10
basic plus 3/4 sterile container .....	11
basic plus 1/1 sterile container .....	12

# Basic Plus 1/2 Sterilcontainer basic plus 1/2 sterile container



310 x 280 x 100 mm					
310 x 280 x 135 mm					
310 x 280 x 150 mm					
310 x 280 x 200 mm					

## BASIC PLUS 1/2

Deckel perforiert, Boden nicht perforiert  
lid perforated, bottom non-perforated





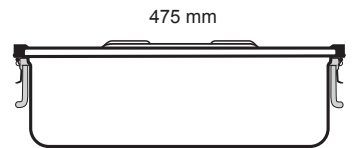
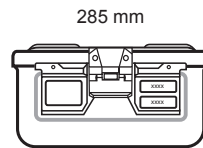

475 x 285 x  
100 mm

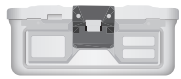

**CE5601S**

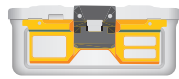

**CE5601Y**

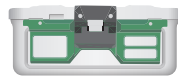

**CE5601G**

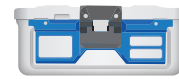

**CE5601B**

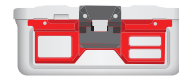

**CE5601R**

475 x 285 x  
135 mm



**CE5603S**



**CE5603Y**

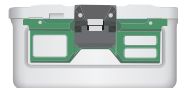

**CE5603G**



**CE5603B**



**CE5603R**

475 x 285 x  
150 mm

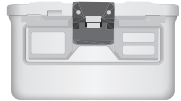

**CE5605S**

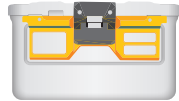

**CE5605Y**

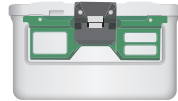

**CE5605G**



**CE5605B**



**CE5605R**

### BASIC PLUS 3/4

Deckel perforiert, Boden nicht perforiert  
lid perforated, bottom non-perforated



# Basic Plus 1/1 Sterilcontainer basic plus 1/1 sterile container



600 x 285 x 100 mm	 <b>CE5701S</b>	 <b>CE5701Y</b>	 <b>CE5701G</b>	 <b>CE5701B</b>	 <b>CE5701R</b>
600 x 285 x 135 mm	 <b>CE5703S</b>	 <b>CE5703Y</b>	 <b>CE5703G</b>	 <b>CE5703B</b>	 <b>CE5703R</b>
600 x 285 x 150 mm	 <b>CE5705S</b>	 <b>CE5705Y</b>	 <b>CE5705G</b>	 <b>CE5705B</b>	 <b>CE5705R</b>
600 x 285 x 200 mm	 <b>CE5707S</b>	 <b>CE5707Y</b>	 <b>CE5707G</b>	 <b>CE5707B</b>	 <b>CE5707R</b>

## BASIC PLUS 1/1

Deckel perforiert, Boden nicht perforiert  
lid perforated, bottom non-perforated





## Basic Sterilcontainer System

### basic sterile container system

Basic 1/2 Sterilcontainer.....	14
Basic 3/4 Sterilcontainer.....	16
Basic 1/1 Sterilcontainer.....	18
Basic MAGNUM Sterilcontainer .....	20
Basic extra lang Sterilcontainer.....	22

basic 1/2 sterile container.....	14
basic 3/4 sterile container.....	16
basic 1/1 sterile container.....	18
basic MAGNUM sterile container .....	20
basic extra long size sterile container.....	22

# Basic 1/2 Sterilcontainer

## basic 1/2 sterile container



	310 x 280 x 100 mm	310 x 280 x 135 mm	310 x 280 x 150 mm	310 x 280 x 200 mm	310 x 280 x 260 mm
	<b>CT5501S</b>	<b>CT5503S</b>	<b>CT5505S</b>	<b>CT5507S</b>	<b>CT5509S</b>
	<b>CT5501Y</b>	<b>CT5503Y</b>	<b>CT5505Y</b>	<b>CT5507Y</b>	<b>CT5509Y</b>
	<b>CT5501G</b>	<b>CT5503G</b>	<b>CT5505G</b>	<b>CT5507G</b>	<b>CT5509G</b>
	<b>CT5501B</b>	<b>CT5503B</b>	<b>CT5505B</b>	<b>CT5507B</b>	<b>CT5509B</b>
	<b>CT5501R</b>	<b>CT5503R</b>	<b>CT5505R</b>	<b>CT5507R</b>	<b>CT5509R</b>
	<b>CT5501A</b>	<b>CT5503A</b>	<b>CT5505A</b>	<b>CT5507A</b>	<b>CT5509A</b>

### BASIC 1/2

Deckel perforiert, Boden nicht perforiert  
lid perforated, bottom non-perforated



	310 x 280 x 100 mm	310 x 280 x 135 mm	310 x 280 x 150 mm	310 x 280 x 200 mm	310 x 280 x 260 mm
	<b>CT5511S</b>	<b>CT5513S</b>	<b>CT5515S</b>	<b>CT5517S</b>	<b>CT5519S</b>
	<b>CT5511Y</b>	<b>CT5513Y</b>	<b>CT5515Y</b>	<b>CT5517Y</b>	<b>CT5519Y</b>
	<b>CT5511G</b>	<b>CT5513G</b>	<b>CT5515G</b>	<b>CT5517G</b>	<b>CT5519G</b>
	<b>CT5511B</b>	<b>CT5513B</b>	<b>CT5515B</b>	<b>CT5517B</b>	<b>CT5519B</b>
	<b>CT5511R</b>	<b>CT5513R</b>	<b>CT5515R</b>	<b>CT5517R</b>	<b>CT5519R</b>
	<b>CT5511A</b>	<b>CT5513A</b>	<b>CT5515A</b>	<b>CT5517A</b>	<b>CT5519A</b>

### BASIC 1/2

Sicherheitsdeckel, Boden nicht perforiert  
safety lid, bottom non-perforated



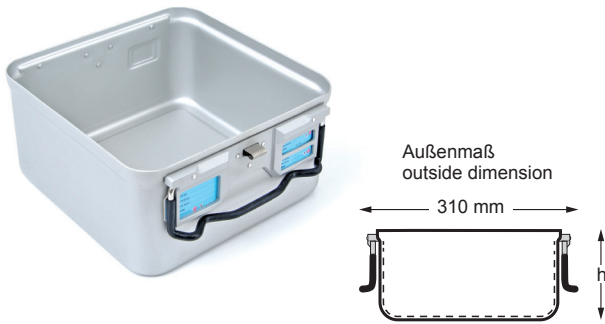

<b>CT5550</b>	310 x 272 x 100 mm
<b>CT5551</b>	310 x 272 x 116 mm
<b>CT5552</b>	310 x 272 x 138 mm
<b>CT5553</b>	310 x 272 x 190 mm
<b>CT5554</b>	310 x 272 x 235 mm



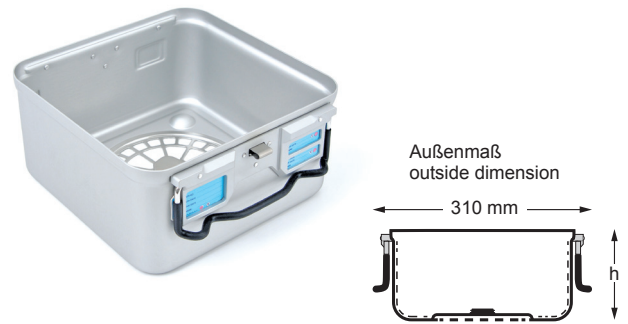



Wannen für 1/2 Sterilcontainer,  
Boden nicht perforiert  
bottoms for 1/2 sterile container,  
bottom non-perforated



<b>CT5560</b>	310 x 272 x 100 mm
<b>CT5561</b>	310 x 272 x 116 mm
<b>CT5562</b>	310 x 272 x 138 mm
<b>CT5563</b>	310 x 272 x 190 mm
<b>CT5564</b>	310 x 272 x 235 mm







Wannen für 1/2 Sterilcontainer,  
Boden perforiert  
bottoms for 1/2 sterile container,  
bottom perforated



-  **CT5572S**
-  **CT5572Y**
-  **CT5572G**
-  **CT5572B**
-  **CT5572R**
-  **CT5572A**

BASIC-Deckel für 1/2 Sterilcontainer, perforiert  
basic lid for 1/2 sterile container, perforated



-  **CT5573S**
-  **CT5573Y**
-  **CT5573G**
-  **CT5573B**
-  **CT5573R**
-  **CT5573A**

Sicherheitsdeckel für 1/2 Sterilcontainer  
safety lid for 1/2 sterile container

# Basic 3/4 Sterilcontainer

## basic 3/4 sterile container

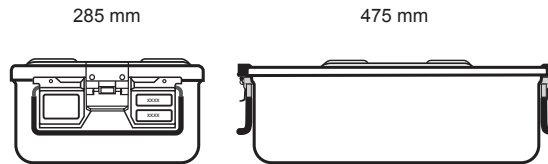

	285 mm	475 mm	
	475 x 285 x 100 mm	475 x 285 x 135 mm	475 x 285 x 150 mm
	<b>CT5601S</b>	<b>CT5603S</b>	<b>CT5605S</b>
	<b>CT5601Y</b>	<b>CT5603Y</b>	<b>CT5605Y</b>
	<b>CT5601G</b>	<b>CT5603G</b>	<b>CT5605G</b>
	<b>CT5601B</b>	<b>CT5603B</b>	<b>CT5605B</b>
	<b>CT5601R</b>	<b>CT5603R</b>	<b>CT5605R</b>
	<b>CT5601A</b>	<b>CT5603A</b>	<b>CT5605A</b>

### BASIC 3/4

Deckel perforiert, Boden nicht perforiert  
lid perforated, bottom non-perforated



	285 mm	475 mm		
	475 x 285 x 100 mm	475 x 285 x 135 mm	475 x 285 x 150 mm	
	<b>CT5611S</b>	<b>CT5613S</b>	<b>CT5615S</b>	
	<b>CT5611Y</b>	<b>CT5613Y</b>	<b>CT5615Y</b>	
	<b>CT5611G</b>	<b>CT5613G</b>	<b>CT5615G</b>	
	<b>CT5611B</b>	<b>CT5613B</b>	<b>CT5615B</b>	
	<b>CT5611R</b>	<b>CT5613R</b>	<b>CT5615R</b>	
	<b>CT5611A</b>	<b>CT5613A</b>	<b>CT5615A</b>	

### BASIC 3/4

Sicherheitsdeckel, Boden nicht perforiert  
safety lid, bottom non-perforated



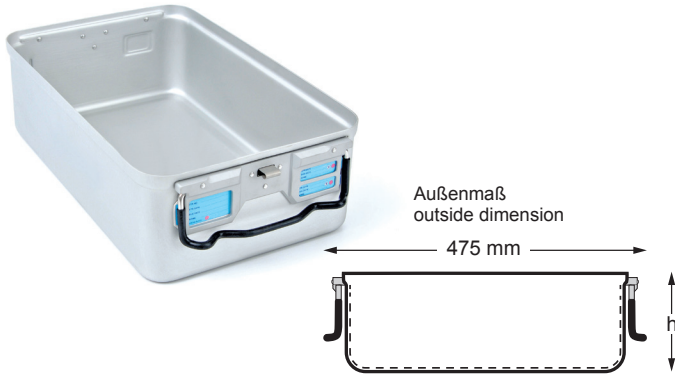

<b>CT5650</b>	475 x 272 x 100 mm
---------------	--------------------

<b>CT5651</b>	475 x 272 x 116 mm
---------------	--------------------

<b>CT5652</b>	475 x 272 x 138 mm
---------------	--------------------

Wannen für 3/4 Sterilcontainer,  
Boden nicht perforiert  
bottoms for 3/4 sterile container,  
bottom non-perforated



<b>CT5660</b>	475 x 272 x 100 mm
---------------	--------------------

<b>CT5661</b>	475 x 272 x 116 mm
---------------	--------------------

<b>CT5662</b>	475 x 272 x 138 mm
---------------	--------------------

Wannen für 3/4 Sterilcontainer,  
Boden perforiert  
bottoms for 3/4 sterile container,  
bottom perforated



	<b>CT5670S</b>
--	----------------

	<b>CT5670Y</b>
--	----------------

	<b>CT5670G</b>
--	----------------

	<b>CT5670B</b>
--	----------------

	<b>CT5670R</b>
--	----------------

	<b>CT5670A</b>
--	----------------

BASIC-Deckel für 3/4 Sterilcontainer, perforiert  
basic lid for 3/4 sterile container, perforated



	<b>CT5673S</b>
---	----------------

	<b>CT5673Y</b>
---	----------------

	<b>CT5673G</b>
---	----------------

	<b>CT5673B</b>
---	----------------

	<b>CT5673R</b>
---	----------------

	<b>CT5673A</b>
---	----------------

Sicherheitsdeckel für 3/4 Sterilcontainer  
safety lid for 3/4 sterile container

# Basic 1/1 Sterilcontainer

## basic 1/1 sterile container

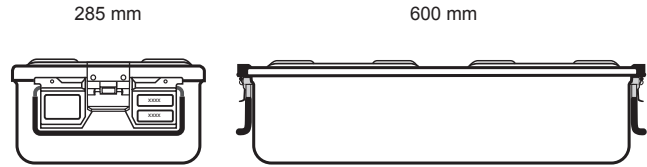

	600 x 285 x 100 mm	600 x 285 x 135 mm	600 x 285 x 150 mm	600 x 285 x 200 mm	600 x 285 x 260 mm
	<b>CT5701S</b>	<b>CT5703S</b>	<b>CT5705S</b>	<b>CT5707S</b>	<b>CT5709S</b>
	<b>CT5701Y</b>	<b>CT5703Y</b>	<b>CT5705Y</b>	<b>CT5707Y</b>	<b>CT5709Y</b>
	<b>CT5701G</b>	<b>CT5703G</b>	<b>CT5705G</b>	<b>CT5707G</b>	<b>CT5709G</b>
	<b>CT5701B</b>	<b>CT5703B</b>	<b>CT5705B</b>	<b>CT5707B</b>	<b>CT5709B</b>
	<b>CT5701R</b>	<b>CT5703R</b>	<b>CT5705R</b>	<b>CT5707R</b>	<b>CT5709R</b>
	<b>CT5701A</b>	<b>CT5703A</b>	<b>CT5705A</b>	<b>CT5707A</b>	<b>CT5709A</b>

### BASIC 1/1

Deckel perforiert, Boden nicht perforiert  
lid perforated, bottom non-perforated



	600 x 285 x 100 mm	600 x 285 x 135 mm	600 x 285 x 150 mm	600 x 285 x 200 mm	600 x 285 x 260 mm
	<b>CT5711S</b>	<b>CT5713S</b>	<b>CT5715S</b>	<b>CT5717S</b>	<b>CT5719S</b>
	<b>CT5711Y</b>	<b>CT5713Y</b>	<b>CT5715Y</b>	<b>CT5717Y</b>	<b>CT5719Y</b>
	<b>CT5711G</b>	<b>CT5713G</b>	<b>CT5715G</b>	<b>CT5717G</b>	<b>CT5719G</b>
	<b>CT5711B</b>	<b>CT5713B</b>	<b>CT5715B</b>	<b>CT5717B</b>	<b>CT5719B</b>
	<b>CT5711R</b>	<b>CT5713R</b>	<b>CT5715R</b>	<b>CT5717R</b>	<b>CT5719R</b>
	<b>CT5711A</b>	<b>CT5713A</b>	<b>CT5715A</b>	<b>CT5717A</b>	<b>CT5719A</b>

### BASIC 1/1

Sicherheitsdeckel, Boden nicht perforiert  
safety lid, bottom non-perforated





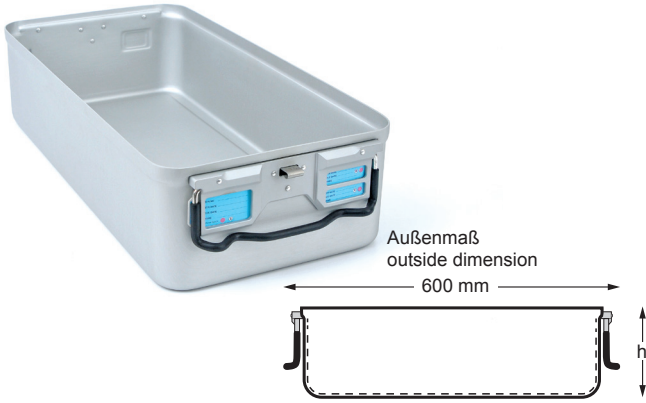

<b>CT5750</b>	600 x 272 x 100 mm
<b>CT5751</b>	600 x 272 x 116 mm
<b>CT5752</b>	600 x 272 x 138 mm
<b>CT5753</b>	600 x 272 x 190 mm
<b>CT5754</b>	600 x 272 x 235 mm

Wannen für 1/1 Sterilcontainer,  
Boden nicht perforiert  
bottoms for 1/1 sterile container,  
bottom non-perforated

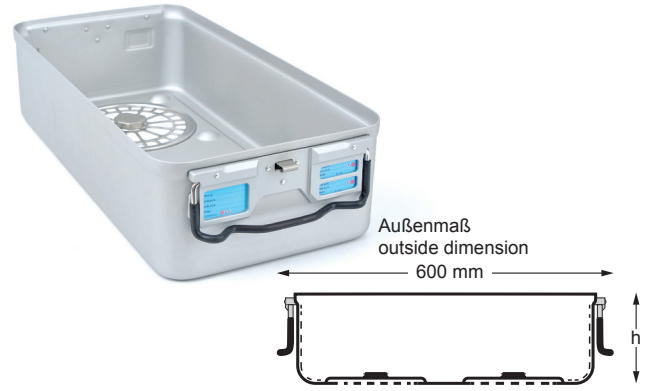

<b>CT5760</b>	600 x 272 x 100 mm
<b>CT5761</b>	600 x 272 x 116 mm
<b>CT5762</b>	600 x 272 x 138 mm
<b>CT5763</b>	600 x 272 x 190 mm
<b>CT5764</b>	600 x 272 x 235 mm

Wannen für 1/1 Sterilcontainer,  
Boden perforiert  
bottoms for 1/1 sterile container,  
bottom perforated



	<b>CT5770S</b>
	<b>CT5770Y</b>
	<b>CT5770G</b>
	<b>CT5770B</b>
	<b>CT5770R</b>
	<b>CT5770A</b>

BASIC-Deckel für 1/1 Sterilcontainer, perforiert  
basic lid for 1/1 sterile container, perforated



	<b>CT5773S</b>
	<b>CT5773Y</b>
	<b>CT5773G</b>
	<b>CT5773B</b>
	<b>CT5773R</b>
	<b>CT5773A</b>

Sicherheitsdeckel für 1/1 Sterilcontainer  
safety lid for 1/1 sterile container

# Basic MAGNUM Sterilcontainer

## basic MAGNUM sterile container



372 mm

600 mm

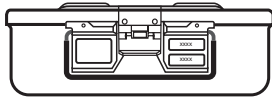
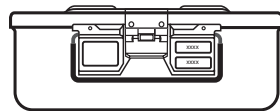

600 x 372 x 120 mm

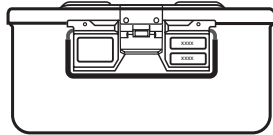

600 x 372 x 185 mm



**CT5802S**

**CT5806S**



**CT5802Y**

**CT5806Y**



**CT5802G**

**CT5806G**



**CT5802B**

**CT5806B**



**CT5802R**

**CT5806R**



**CT5802A**

**CT5806A**

### BASIC MAGNUM

Deckel perforiert, Boden nicht perforiert  
lid perforated, bottom non-perforated



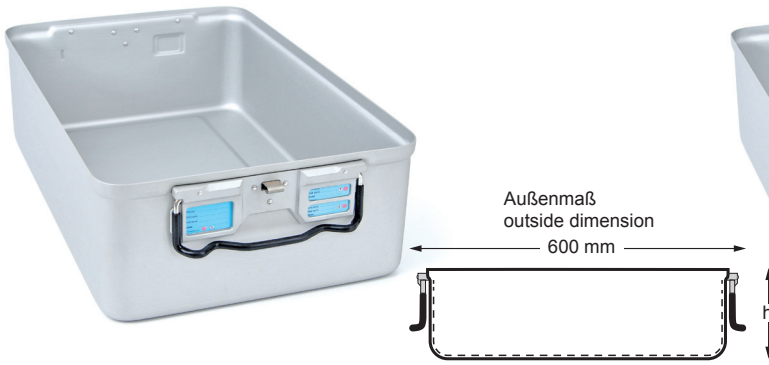

<b>CT5850</b>	600 x 365 x 105 mm
<b>CT5851</b>	600 x 365 x 167 mm



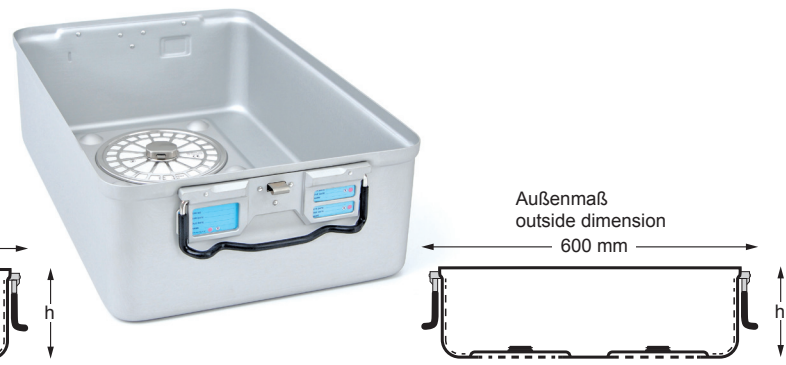



Wannen für MAGNUM Sterilcontainer,  
Boden nicht perforiert  
bottoms for MAGNUM sterile container,  
bottom non-perforated



<b>CT5860</b>	600 x 365 x 105 mm
<b>CT5861</b>	600 x 365 x 167 mm

Wannen für MAGNUM Sterilcontainer,  
Boden perforiert  
bottoms for MAGNUM sterile container,  
bottom perforated



	<b>CT5870S</b>
	<b>CT5870Y</b>
	<b>CT5870G</b>
	<b>CT5870B</b>
	<b>CT5870R</b>
	<b>CT5870A</b>

BASIC-Deckel für MAGNUM Sterilcontainer,  
perforiert  
basic lid for MAGNUM sterile container,  
perforated

# Basic extra lang Sterilcontainer

## basic extra long size sterile container



285 mm

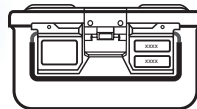

725 mm

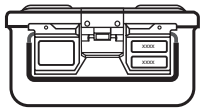

725 x 285 x 140 mm

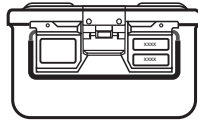

725 x 285 x 205 mm



**CT5902S**

**CT5906S**



**CT5902Y**

**CT5906Y**



**CT5902G**

**CT5906G**



**CT5902B**

**CT5906B**



**CT5902R**

**CT5906R**



**CT5902A**

**CT5906A**

### BASIC EXTRA LONG

Deckel perforiert, Boden nicht perforiert  
lid perforated, bottom non-perforated



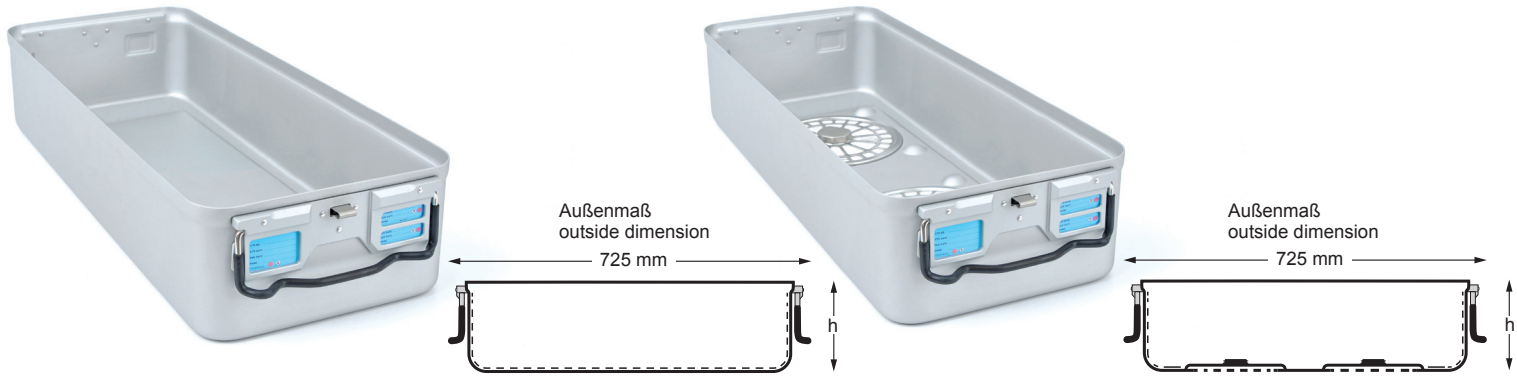

<b>CT5950</b>	725 x 272 x 127 mm
---------------	--------------------

<b>CT5951</b>	725 x 272 x 192 mm
---------------	--------------------

Wannen für extra lange Sterilcontainer,  
Boden nicht perforiert  
bottoms for extra long sterile  
container, bottom non-perforated

<b>CT5960</b>	725 x 272 x 127 mm
---------------	--------------------

<b>CT5961</b>	725 x 272 x 192 mm
---------------	--------------------

Wannen für extra lange Sterilcontainer,  
Boden perforiert  
bottoms for extra long sterile  
container, bottom perforated



	<b>CT5970S</b>
--	----------------

	<b>CT5970Y</b>
--	----------------

	<b>CT5970G</b>
--	----------------

	<b>CT5970B</b>
--	----------------

	<b>CT5970R</b>
--	----------------

	<b>CT5970A</b>
--	----------------

BASIC-Deckel für extra lange Sterilcontainer,  
perforiert  
basic lid for extra long sterile container,  
perforated





## Multi Flex Sterilcontainer System

### multi flex sterile container system

Multi Flex Filtersystem und Deckel .....	26
Multi Flex 1/2 Sterilcontainer .....	27
Multi Flex 3/4 Sterilcontainer .....	28
Multi Flex 1/1 Sterilcontainer .....	29
Multi Flex MAGNUM Sterilcontainer.....	30
Multi Flex extra lang Sterilcontainer .....	31

multi flex filter system and lid.....	26
multi flex 1/2 sterile container.....	27
multi flex 3/4 sterile container.....	28
multi flex 1/1 sterile container.....	29
multi flex MAGNUM sterile container.....	30
multi flex extra long size sterile container.....	31

# Multi Flex Filtersystem und Deckel multi flex filter system and lid



PTFE	Valve	Biostop PPS	Biostop Aluminium
<b>CT5775P</b>	<b>CT5775V</b>	<b>CT5775B</b>	<b>CT5775A</b>

## MULTI FLEX

Filtersystem allein  
filter system alone

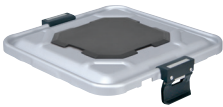

<b>CT5574BS-1</b>	<b>CT5574AS-1</b>	1/2 Modell Deckel ohne Filtersystem 1/2 model lid without filtering mechanism	grau grey
<b>CT5674BS-1</b>	<b>CT5674AS-1</b>	3/4 Modell Deckel ohne Filtersystem 3/4 model lid without filtering mechanism	grau grey
<b>CT5774BS-1</b>	<b>CT5774AS-1</b>	1/1 Modell Deckel ohne Filtersystem 1/1 model lid without filtering mechanism	grau grey
<b>CT5874BS-1</b>	<b>CT5874AS-1</b>	MAGNUM Modell Deckel ohne Filtersystem MAGNUM model lid without filtering mechanism	grau grey
<b>CT5974BS-1</b>	<b>CT5974AS-1</b>	extra lang Modell Deckel ohne Filtersystem extra long model lid without filtering mechanism	grau grey

## MULTI FLEX

Deckel einzeln  
lid only



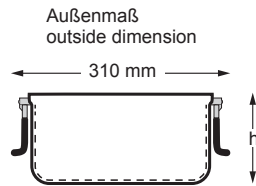

310 x 272 x 100 mm	310 x 272 x 116 mm	310 x 272 x 138 mm	310 x 272 x 190 mm	310 x 272 x 235 mm
<b>CT5550</b>	<b>CT5551</b>	<b>CT5552</b>	<b>CT5553</b>	<b>CT5554</b>

Wannen für 1/2 Sterilcontainer, Boden nicht perforiert  
bottoms for 1/2 sterile container, bottom non-perforated



	PTFE	Valve	Biostop PPS	Biostop Aluminium
	<b>CT5574PS</b>	<b>CT5574VS</b>	<b>CT5574BS</b>	<b>CT5574AS</b>
	<b>CT5574PY</b>	<b>CT5574VY</b>	<b>CT5574BY</b>	<b>CT5574AY</b>
	<b>CT5574PG</b>	<b>CT5574VG</b>	<b>CT5574BG</b>	<b>CT5574AG</b>
	<b>CT5574PB</b>	<b>CT5574VB</b>	<b>CT5574BB</b>	<b>CT5574AB</b>
	<b>CT5574PR</b>	<b>CT5574VR</b>	<b>CT5574BR</b>	<b>CT5574AR</b>
	<b>CT5574PA</b>	<b>CT5574VA</b>	<b>CT5574BA</b>	<b>CT5574AA</b>



### MULTI FLEX 1/2

Deckel für 1/2 Sterilcontainer  
lid for 1/2 sterile container



	<b>CT5573S</b>
	<b>CT5573Y</b>
	<b>CT5573G</b>
	<b>CT5573B</b>
	<b>CT5573R</b>
	<b>CT5573A</b>

Sicherheitsdeckel für 1/2 Sterilcontainer  
safety lid for 1/2 sterile container

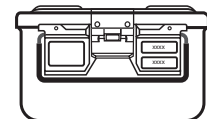

Maße komplett  
dimension complete

310 x 280 x 100 mm

310 x 280 x 135 mm

310 x 280 x 150 mm

310 x 280 x 200 mm

310 x 280 x 260 mm

# Multi Flex 3/4 Sterilcontainer multi flex 3/4 sterile container

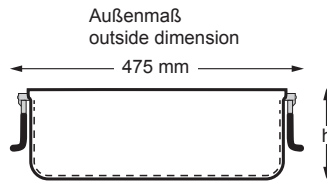

475 x 272 x 100 mm	475 x 272 x 116 mm	475 x 272 x 138 mm
<b>CT5650</b>	<b>CT5651</b>	<b>CT5652</b>

Wannen für 3/4 Sterilcontainer, Boden nicht perforiert  
bottoms for 3/4 sterile container, bottom non-perforated



PTFE

Valve

Biostop PPS

Biostop  
Aluminium



**CT5674PS**

**CT5674VS**

**CT5674BS**

**CT5674AS**



**CT5674PY**

**CT5674VY**

**CT5674BY**

**CT5674AY**



**CT5674PG**

**CT5674VG**

**CT5674BG**

**CT5674AG**



**CT5674PB**

**CT5674VB**

**CT5674BB**

**CT5674AB**



**CT5674PR**

**CT5674VR**

**CT5674BR**

**CT5674AR**



**CT5674PA**

**CT5674VA**

**CT5674BA**

**CT5674AA**



## MULTI FLEX 3/4

Deckel für 3/4 Sterilcontainer  
lid for 3/4 sterile container



**CT5673S**



**CT5673Y**



**CT5673G**



**CT5673B**



**CT5673R**



**CT5673A**

Sicherheitsdeckel für 3/4 Sterilcontainer  
safety lid for 3/4 sterile container

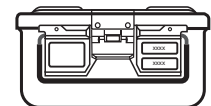

Maße komplett  
dimension complete

475 x 285 x 100 mm

475 x 285 x 135 mm

475 x 285 x 150 mm

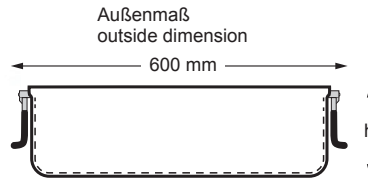

600 x 272 x 100 mm	600 x 272 x 116 mm	600 x 272 x 138 mm	600 x 272 x 190 mm	600 x 272 x 235 mm
<b>CT5750</b>	<b>CT5751</b>	<b>CT5752</b>	<b>CT5753</b>	<b>CT5754</b>

Wannen für 1/1 Sterilcontainer, Boden nicht perforiert  
bottoms for 1/1 sterile container, bottom non-perforated



	PTFE	Valve	Biostop PPS	Biostop Aluminium
	<b>CT5774PS</b>	<b>CT5774VS</b>	<b>CT5774BS</b>	<b>CT5774AS</b>
	<b>CT5774PY</b>	<b>CT5774VY</b>	<b>CT5774BY</b>	<b>CT5774AY</b>
	<b>CT5774PG</b>	<b>CT5774VG</b>	<b>CT5774BG</b>	<b>CT5774AG</b>
	<b>CT5774PB</b>	<b>CT5774VB</b>	<b>CT5774BB</b>	<b>CT5774AB</b>
	<b>CT5774PR</b>	<b>CT5774VR</b>	<b>CT5774BR</b>	<b>CT5774AR</b>
	<b>CT5774PA</b>	<b>CT5774VA</b>	<b>CT5774BA</b>	<b>CT5774AA</b>

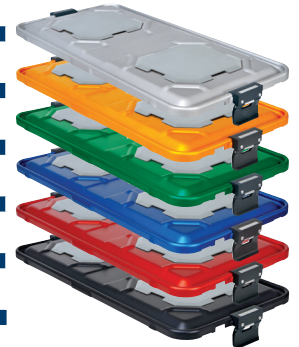
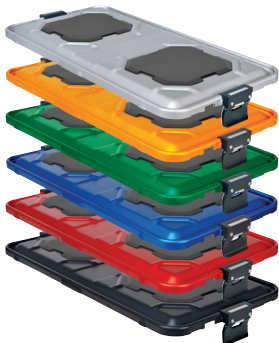

## MULTI FLEX 1/1

Deckel für 1/1 Sterilcontainer  
lid for 1/1 sterile container



	<b>CT5773S</b>
	<b>CT5773Y</b>
	<b>CT5773G</b>
	<b>CT5773B</b>
	<b>CT5773R</b>
	<b>CT5773A</b>

Sicherheitsdeckel für 1/1 Sterilcontainer  
safety lid for 1/1 sterile container

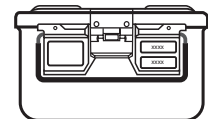

Maße komplett  
dimension complete

600 x 285 x 100 mm

600 x 285 x 135 mm

600 x 285 x 150 mm

600 x 285 x 200 mm

600 x 285 x 260 mm

# Multi Flex MAGNUM Sterilcontainer

## multi flex MAGNUM sterile container

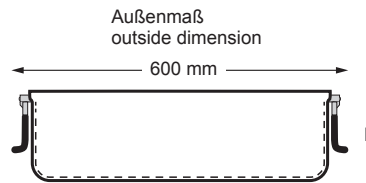

600 x 365 x 105 mm

600 x 365 x 167 mm

**CT5850**

**CT5851**

Wannen für MAGNUM Sterilcontainer, Boden nicht perforiert  
bottoms for MAGNUM sterile container, bottom non-perforated



PTFE

Valve

Biostop PPS

Biostop  
Aluminium



**CT5874PS**

**CT5874VS**

**CT5874BS**

**CT5874AS**



**CT5874PY**

**CT5874VY**

**CT5874BY**

**CT5874AY**



**CT5874PG**

**CT5874VG**

**CT5874BG**

**CT5874AG**



**CT5874PB**

**CT5874VB**

**CT5874BB**

**CT5874AB**



**CT5874PR**

**CT5874VR**

**CT5874BR**

**CT5874AR**



**CT5874PA**

**CT5874VA**

**CT5874BA**

**CT5874AA**

### MULTI FLEX MAGNUM

Deckel für MAGNUM Sterilcontainer  
lid for MAGNUM sterile container

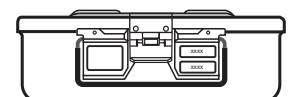
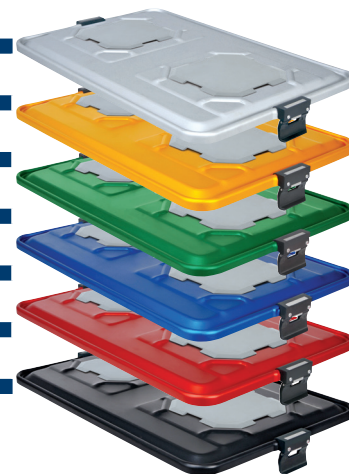

Maße komplett  
dimension complete

600 x 372 x 120 mm



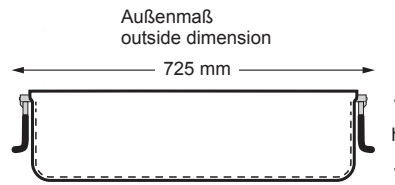



600 x 372 x 185 mm



725 x 272 x 127 mm	725 x 272 x 192 mm
<b>CT5950</b>	<b>CT5951</b>

Wannen für extra lange Sterilcontainer, Boden nicht perforiert  
 bottoms for extra long sterile container, bottom non-perforated



	PTFE	Valve	Biostop PPS	Biostop Aluminium
	<b>CT5974PS</b>	<b>CT5974VS</b>	<b>CT5974BS</b>	<b>CT5974AS</b>
	<b>CT5974PY</b>	<b>CT5974VY</b>	<b>CT5974BY</b>	<b>CT5974AY</b>
	<b>CT5974PG</b>	<b>CT5974VG</b>	<b>CT5974BG</b>	<b>CT5974AG</b>
	<b>CT5974PB</b>	<b>CT5974VB</b>	<b>CT5974BB</b>	<b>CT5974AB</b>
	<b>CT5974PR</b>	<b>CT5974VR</b>	<b>CT5974BR</b>	<b>CT5974AR</b>
	<b>CT5974PA</b>	<b>CT5974VA</b>	<b>CT5974BA</b>	<b>CT5974AA</b>



## MULTI FLEX EXTRA LONG

Deckel für extra lange Sterilcontainer  
 lid for extra long sterile container

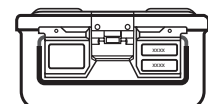

Maße komplett  
 dimension complete

725 x 285 x 140 mm

725 x 285 x 205 mm





## Dental, Mini und Spezial Container

### dental, mini and special container

Dental Container.....	34
Mini Container .....	40
Container flaches Modell .....	42
Endoskop Container .....	44
Container für Transport- und Lagerzwecke .....	46

dental container .....	34
mini container .....	40
container flat model .....	42
endoscopes container .....	44
container for transport and storage .....	46

# Dental Container

## dental container

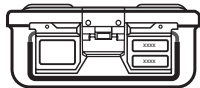
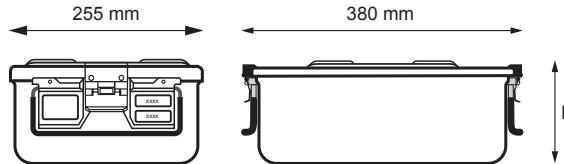

380 x 255 x 100 mm

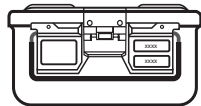

380 x 255 x 135 mm

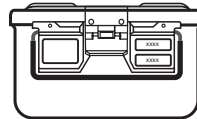

380 x 255 x 150 mm



**CT5321S**

**CT5322S**

**CT5323S**



**CT5321Y**

**CT5322Y**

**CT5323Y**



**CT5321G**

**CT5322G**

**CT5323G**



**CT5321B**

**CT5322B**

**CT5323B**



**CT5321R**

**CT5322R**

**CT5323R**



**CT5321A**

**CT5322A**

**CT5323A**

### LARGE DENTAL MODEL

Deckel perforiert, Boden nicht perforiert  
lid perforated, bottom non-perforated





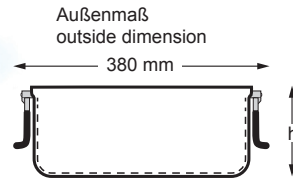

<b>CT5324</b>	380 x 244 x 100 mm
<b>CT5325</b>	380 x 244 x 116 mm
<b>CT5326</b>	380 x 244 x 138 mm







Wannen, Boden nicht perforiert  
bottoms, bottom non-perforated



-  **CT5320S**
-  **CT5320Y**
-  **CT5320G**
-  **CT5320B**
-  **CT5320R**
-  **CT5320A**

Deckel, perforiert  
lid, perforated



















































-  **CT5320VS**
-  **CT5320VY**
-  **CT5320VG**
-  **CT5320VB**
-  **CT5320VR**
-  **CT5320VA**

Deckel, Barrier System  
lid, barrier system

# Dental Container

## dental container

				
	Deckel perforiert, Boden nicht perforiert lid perforated, bottom non-perforated	Deckel perforiert, Boden perforiert lid perforated, bottom perforated	Boden perforiert bottom perforated	Boden nicht perforiert bottom non-perforated
325 x 192 x 55 mm 	CT5202S 	CT5207S 		
	CT5202Y 	CT5207Y 		
	CT5202G 	CT5207G 	CT5217 	CT5212 
	CT5202B 	CT5207B 		
	CT5202R 	CT5207R 		
	CT5202A 	CT5207A 		
325 x 190 x 70 mm 	CT5204S 	CT5208S 		
	CT5204Y 	CT5208Y 		
	CT5204G 	CT5208G 	CT5218 	CT5214 
	CT5204B 	CT5208B 		
	CT5204R 	CT5208R 		
	CT5204A 	CT5208A 		
325 x 190 x 135 mm 	CT5206S 	CT5210S 		
	CT5206Y 	CT5210Y 		
	CT5206G 	CT5210G 	CT5220 	CT5216 
	CT5206B 	CT5210B 		
	CT5206R 	CT5210R 		
	CT5206A 	CT5210A 		

### DENTAL MODEL

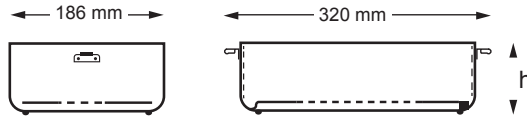

	<b>CT5217</b>	320 x 186 x 43 mm		<b>CT5212</b>	320 x 186 x 43 mm
	<b>CT5218</b>	320 x 186 x 58 mm		<b>CT5214</b>	320 x 186 x 59 mm
	<b>CT5220</b>	320 x 186 x 122 mm		<b>CT5216</b>	320 x 186 x 122 mm

Wannen, Boden perforiert  
bottoms, bottom perforated

Wannen, Boden nicht perforiert - massiv  
bottoms, bottom non-perforated - solid



- CT5201S**
- CT5201Y**
- CT5201G**
- CT5201B**
- CT5201R**
- CT5201A**

Deckel, perforiert  
lid, perforated



















































- CT5201VS**
- CT5201VY**
- CT5201VG**
- CT5201VB**
- CT5201VR**
- CT5201VA**

Deckel, Bio Barrier  
lid, bio barrier





# Dental Container

## dental container

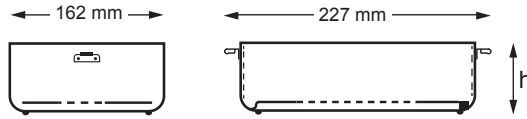
				
	Deckel perforiert, Boden nicht perforiert lid perforated, bottom non-perforated	Deckel perforiert, Boden perforiert lid perforated, bottom perforated	Boden perforiert bottom perforated	Boden nicht perforiert bottom non-perforated
232 x 174 x 63 mm 	CT0102S 	CT0107S 	CT0117 	CT0112 
	CT0102Y 	CT0107Y 		
	CT0102G 	CT0107G 		
	CT0102B 	CT0107B 		
	CT0102R 	CT0107R 		
	CT0102A 	CT0107A 		
232 x 174 x 100 mm 	CT0104S 	CT0108S 	CT0118 	CT0114 
	CT0104Y 	CT0108Y 		
	CT0104G 	CT0108G 		
	CT0104B 	CT0108B 		
	CT0104R 	CT0108R 		
	CT0104A 	CT0108A 		
232 x 174 x 130 mm 	CT0106S 	CT0110S 	CT0120 	CT0116 
	CT0106Y 	CT0110Y 		
	CT0106G 	CT0110G 		
	CT0106B 	CT0110B 		
	CT0106R 	CT0110R 		
	CT0106A 	CT0110A 		

1/2 DENTAL MODEL



	<b>CT0117</b>	227 x 162 x 57 mm		<b>CT0112</b>	227 x 162 x 57 mm
	<b>CT0118</b>	227 x 162 x 88 mm		<b>CT0114</b>	227 x 162 x 88 mm
	<b>CT0120</b>	227 x 162 x 122 mm		<b>CT0116</b>	227 x 162 x 122 mm

Wannen, Boden perforiert  
bottoms, bottom perforated

Wannen, Boden nicht perforiert - massiv  
bottoms, bottom non-perforated - solid















































-  **CT0101S**
-  **CT0101Y**
-  **CT0101G**
-  **CT0101B**
-  **CT0101R**
-  **CT0101A**

Deckel, perforiert  
lid, perforated

# Mini Container

## mini container

				
	Deckel perforiert, Boden nicht perforiert lid perforated, bottom non-perforated	Deckel perforiert, Boden perforiert lid perforated, bottom perforated	Boden perforiert bottom perforated	Boden nicht perforiert bottom non-perforated
315 x 142 x 45 mm 	CT5301S 	CT5302S 	CT5312 	CT5311 
	CT5301Y 	CT5302Y 		
	CT5301G 	CT5302G 		
	CT5301B 	CT5302B 		
	CT5301R 	CT5302R 		
	CT5301A 	CT5302A 		
	315 x 142 x 70 mm 	CT5303S 		
CT5303Y 		CT5304Y 		
CT5303G 		CT5304G 		
CT5303B 		CT5304B 		
CT5303R 		CT5304R 		
CT5303A 		CT5304A 		
315 x 142 x 100 mm 		CT5305S 	CT5306S 	CT5316 
	CT5305Y 	CT5306Y 		
	CT5305G 	CT5306G 		
	CT5305B 	CT5306B 		
	CT5305R 	CT5306R 		
	CT5305A 	CT5306A 		

### MINI MODEL

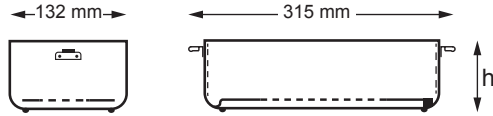

	<b>CT5312</b>	315 x 132 x 32 mm		<b>CT5311</b>	315 x 132 x 32 mm
	<b>CT5314</b>	315 x 132 x 63 mm		<b>CT5313</b>	315 x 132 x 63 mm
	<b>CT5316</b>	315 x 132 x 92 mm		<b>CT5315</b>	315 x 132 x 92 mm

Wannen, Boden perforiert  
bottoms, bottom perforated

Wannen, Boden nicht perforiert - massiv  
bottoms, bottom non-perforated - solid



- CT5300S**
- CT5300Y**
- CT5300G**
- CT5300B**
- CT5300R**
- CT5300A**





























Deckel, perforiert  
lid, perforated



- CT5300VS**
- CT5300VY**
- CT5300VG**
- CT5300VB**
- CT5300VR**
- CT5300VA**

Deckel, Bio Barrier  
lid, bio barrier

# Container flaches Modell container flat model

				
	Deckel perforiert, Boden nicht perforiert lid perforated, bottom non-perforated	Deckel perforiert, Boden perforiert lid perforated, bottom perforated	Boden perforiert bottom perforated	Boden nicht perforiert bottom non-perforated
297 x 280 x 75 mm 	CT0122S 	CT0127S 	CT0135	CT0132
	CT0122Y 	CT0127Y 		
	CT0122G 	CT0127G 		
	CT0122B 	CT0127B 		
	CT0122R 	CT0127R 		
	CT0122A 	CT0127A 		
	CT0124S 	CT0129S 		
CT0124Y 	CT0129Y 			
CT0124G 	CT0129G 			
CT0124B 	CT0129B 			
CT0124R 	CT0129R 			
CT0124A 	CT0129A 			

## FLAT MODEL



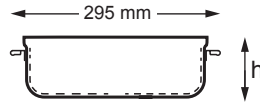
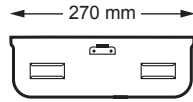

**CT0135**

295 x 270 x 60 mm



**CT0132**

295 x 270 x 60 mm



**CT0136**

295 x 270 x 72 mm



**CT0134**

295 x 270 x 72 mm

Wannen, Boden perforiert  
bottoms, bottom perforated

Wannen, Boden nicht perforiert - massiv  
bottoms, bottom non-perforated - solid



**CT0121S**

**CT0121Y**

**CT0121G**

**CT0121B**

**CT0121R**

**CT0121A**

Deckel, perforiert  
lid, perforated



**CT0121VS**

**CT0121VY**

**CT0121VG**

**CT0121VB**





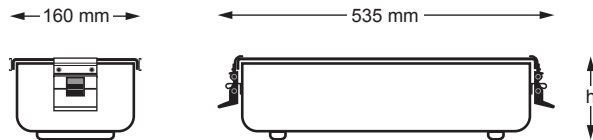

**CT0121VR**

**CT0121VA**

Deckel, Bio Barrier  
lid, bio-barrier

# Endoskop Container endoscope container



	<b>CT5115S</b>	535 x 160 x 75 mm
	<b>CT5116S</b>	535 x 160 x 100 mm
	<b>CT5115Y</b>	535 x 160 x 75 mm
	<b>CT5116Y</b>	535 x 160 x 100 mm
	<b>CT5115G</b>	535 x 160 x 75 mm
	<b>CT5116G</b>	535 x 160 x 100 mm
	<b>CT5115B</b>	535 x 160 x 75 mm
	<b>CT5116B</b>	535 x 160 x 100 mm
	<b>CT5115R</b>	535 x 160 x 75 mm
	<b>CT5116R</b>	535 x 160 x 100 mm
	<b>CT5115A</b>	535 x 160 x 75 mm
	<b>CT5116A</b>	535 x 160 x 100 mm

Deckel und Wanne perforiert  
lid and bottom perforated



←145 mm→









←528 mm→































<b>CT5117</b>	528 x 145 x 64 mm
<b>CT5118</b>	528 x 145 x 88 mm





























-  **CT5119S**
-  **CT5119Y**
-  **CT5119G**
-  **CT5119B**
-  **CT5119R**
-  **CT5119A**

Deckel, perforiert  
lid, perforated































# Implantate Container für Transport- und Lagerzwecke implants container for transport and storage

				
kein Filter non filter		Deckel perforiert, Boden nicht perforiert lid perforated, bottom non-perforated	Deckel perforiert, Boden perforiert lid perforated, bottom perforated	
300 x 150 x 75 mm		CT5101A 	CT5102A 	
		CT5101R 	CT5102R 	
		CT5101B 	CT5102B 	
		CT5101G 	CT5102G 	
		CT5101Y 	CT5102Y 	
		CT5101S 	CT5102S 	
		CT5103A 	CT5104A 	
CT5103R 	CT5104R 			
CT5103B 	CT5104B 			
CT5103G 	CT5104G 			
CT5103Y 	CT5104Y 			
CT5103S 	CT5104S 			

















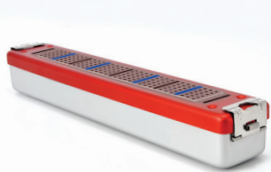













## IMPLANT MODEL CONTAINER

				
kein Filter non filter		Deckel perforiert, Boden nicht perforiert lid perforated, bottom non-perforated	Deckel perforiert, Boden perforiert lid perforated, bottom perforated	
160 x 72 x 57 mm		CT5121A 	CT5122A 	
		CT5121R 	CT5122R 	
		CT5121B 	CT5122B 	
		CT5121G 	CT5122G 	
		CT5121Y 	CT5122Y 	
		CT5121S 	CT5122S 	
		200 x 147 x 57 mm		
CT5123R 	CT5124R 			
CT5123B 	CT5124B 			
CT5123G 	CT5124G 			
CT5123Y 	CT5124Y 			
CT5123S 	CT5124S 			

## MINI IMPLANT MODEL CONTAINER

kein Filter non filter		 Deckel perforiert, Boden nicht perforiert lid perforated, bottom non-perforated	 Deckel perforiert, Boden perforiert lid perforated, bottom perforated	
260 x 70 x 60 mm		CT5113A 	CT5111A 	
		CT5113R 	CT5111R 	
		CT5113B 	CT5111B 	
		CT5113G 	CT5111G 	
		CT5113Y 	CT5111Y 	
		CT5113S 	CT5111S 	
455 x 80 x 70 mm		CT5114A 	CT5112A 	
		CT5114R 	CT5112R 	
		CT5114B 	CT5112B 	
		CT5114G 	CT5112G 	
		CT5114Y 	CT5112Y 	
		CT5114S 	CT5112S 	

### ENDOSCOPE CONTAINER

kein Filter non filter		 Deckel perforiert, Boden nicht perforiert lid perforated, bottom non-perforated	 Deckel perforiert, Boden perforiert lid perforated, bottom perforated	
275 x 70 x 65 mm		CT5131A 	CT5132A 	
		CT5131R 	CT5132R 	
		CT5131B 	CT5132B 	
		CT5131G 	CT5132G 	
		CT5131Y 	CT5132Y 	
		CT5131S 	CT5132S 	
470 x 82 x 74 mm		CT5133A 	CT5134A 	
		CT5133R 	CT5134R 	
		CT5133B 	CT5134B 	
		CT5133G 	CT5134G 	
		CT5133Y 	CT5134Y 	
		CT5133S 	CT5134S 	

### ENDOSCOPE CONTAINER

mit Silikonhalter, Sperre, Etikett  
with silicon holder, lock, label

# Container für Bürsten zu Transport- und Lagerzwecke container for brushes to transport and storage



## Container für Bürsten

- mit Wandbefestigungsvorrichtungen
- für maximal 20 Bürsten
- Um eine Bürste zu entnehmen, bewegen Sie den Griff nach rechts oder links.

## container for brushes

- with wall mounting fixtures
- for a maximum of 20 brushes
- For brush removal, you move the handle to the right or to the left.



<b>CT5991A</b>	280 x 293 x 85 mm
<b>CT5991R</b>	280 x 293 x 85 mm
<b>CT5991B</b>	280 x 293 x 85 mm
<b>CT5991G</b>	280 x 293 x 85 mm
<b>CT5991Y</b>	280 x 293 x 85 mm
<b>CT5991S</b>	280 x 293 x 85 mm

## BRUSH MODEL

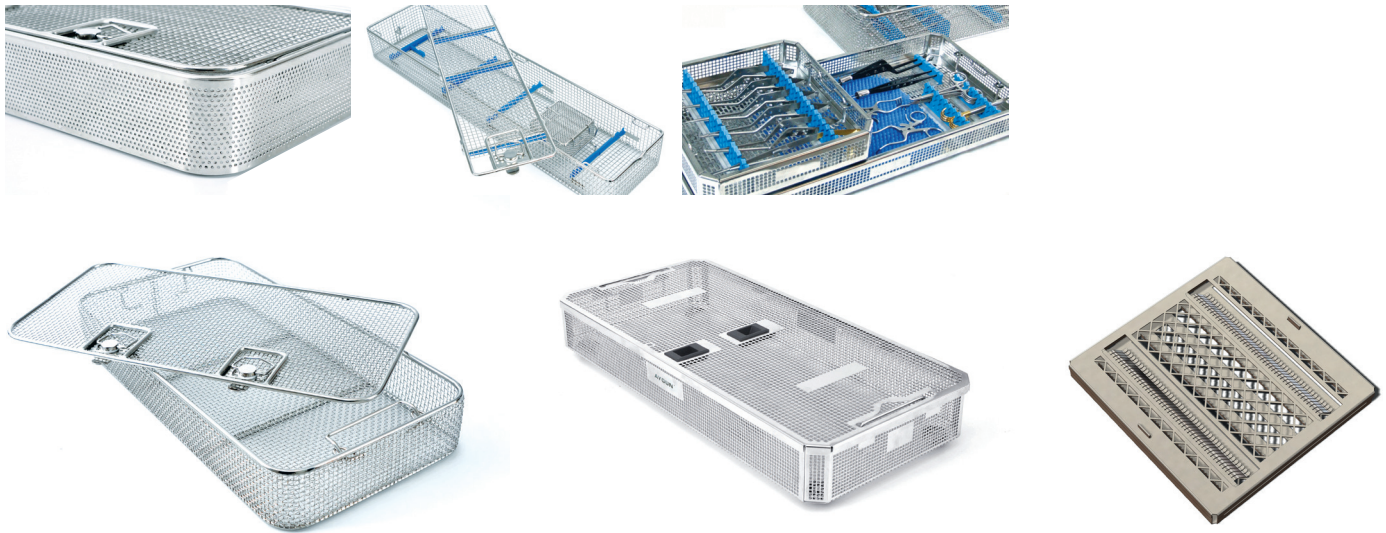

## Siebkörbe wire baskets

Siebkörbe .....	50
Silikonbefestigungssystem .....	55
Quick Fix Siebkörbe .....	63
Quick Fix Rack .....	68
Dental- und Minikörbe .....	69
Endoskopiekörbe .....	71
Rack .....	72
Drahtkörbe für Organistaion und Lagerung .....	75
Einschlagtücher .....	77
Dentalkörbe und Trays .....	78

wire baskets.....	50
silicone fixation system.....	55
Quick Fix trays.....	63
Quick Fix rack.....	68
dental and mini baskets.....	69
endoscope baskets.....	71
rack.....	72
wire baskets for organisation ans storage .....	75
drapes.....	77
dental baskets and trays.....	78

# Siebkörbe wire baskets

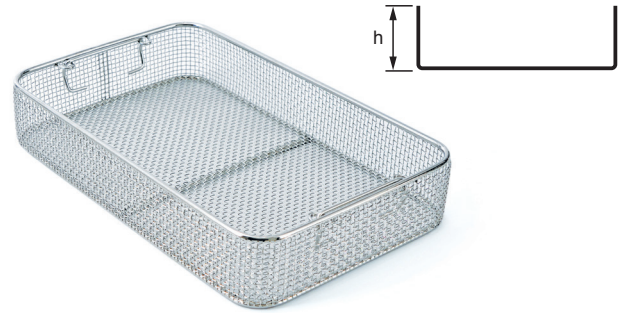
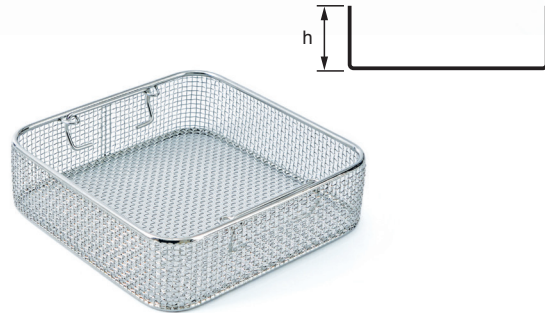
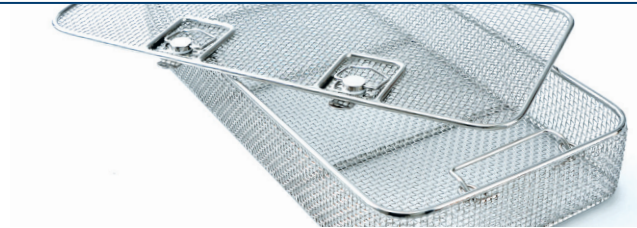

		für Flachmodell for flat model
<b>ST5580</b>	255 x 250 x 30 mm	•
<b>ST5581</b>	255 x 250 x 50 mm	•
<b>ST5582</b>	255 x 250 x 70 mm	
<b>ST5583</b>	255 x 250 x 100 mm	
<b>ST5579</b>	Deckel allein, für Wanne only lid, for basket	

Siebkorb 1/2 - auch für Flachmodell  
wire basket 1/2 - also for flat model

<b>ST5680</b>	405 x 250 x 30 mm
<b>ST5681</b>	405 x 250 x 50 mm
<b>ST5682</b>	405 x 250 x 70 mm
<b>ST5683</b>	405 x 250 x 100 mm
<b>ST5679</b>	Deckel allein, für Wanne only lid, for basket

Siebkorb 3/4  
wire basket 3/4

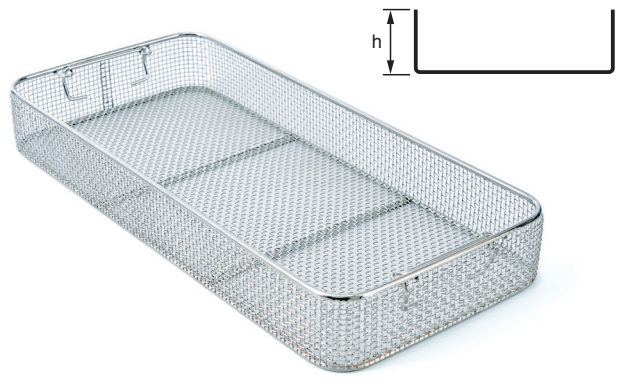
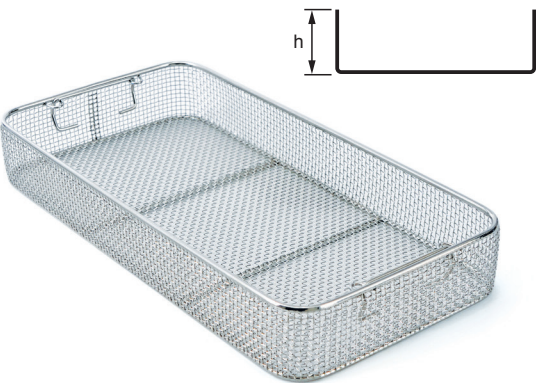

<b>ST5780</b>	480 x 250 x 30 mm
<b>ST5781</b>	480 x 250 x 50 mm
<b>ST5782</b>	480 x 250 x 70 mm
<b>ST5783</b>	480 x 250 x 100 mm
<b>ST5779</b>	Deckel allein, für Wanne only lid, for basket

Siebkorb 1/1  
wire basket 1/1

<b>ST5784</b>	540 x 250 x 30 mm
<b>ST5785</b>	540 x 250 x 50 mm
<b>ST5786</b>	540 x 250 x 70 mm
<b>ST5787</b>	540 x 250 x 100 mm
<b>ST5789</b>	Deckel allein, für Wanne only lid, for basket

Siebkorb 1/1 lang  
wire basket 1/1 long



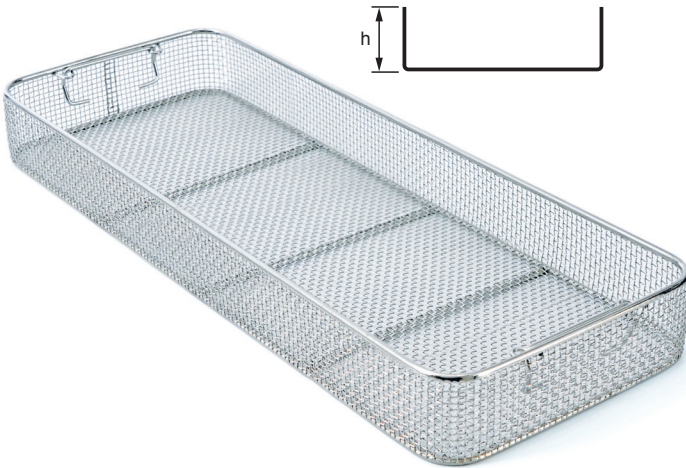

<b>ST5962</b>	665 x 250 x 50 mm
<b>ST5963</b>	665 x 250 x 70 mm
<b>ST5964</b>	665 x 250 x 100 mm
<b>ST5965</b>	Deckel allein, für Wanne only lid, for basket

Siebkorb extra lang  
wire basket extra long

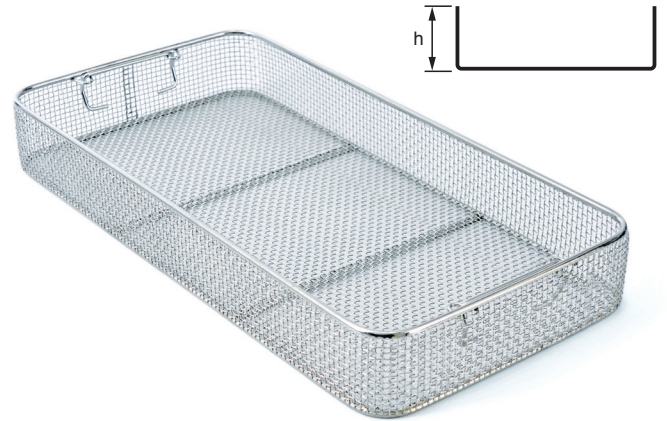

<b>ST5871</b>	533 x 337 x 50 mm
<b>ST5872</b>	533 x 337 x 70 mm
<b>ST5873</b>	533 x 337 x 100 mm
<b>ST5874</b>	Deckel allein, für Wanne only lid, for basket

Siebkorb MAGNUM  
wire basket MAGNUM

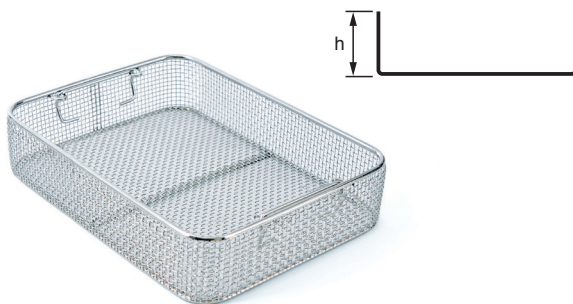

<b>ST5370</b>	320 x 220 x 50 mm
<b>ST5371</b>	320 x 220 x 70 mm
<b>ST5372</b>	320 x 220 x 100 mm
<b>ST5373</b>	Deckel allein, für Wanne only lid, for basket

Siebkorb breites Dentalmodell  
wire basket large dental model



# Siebkörbe wire baskets

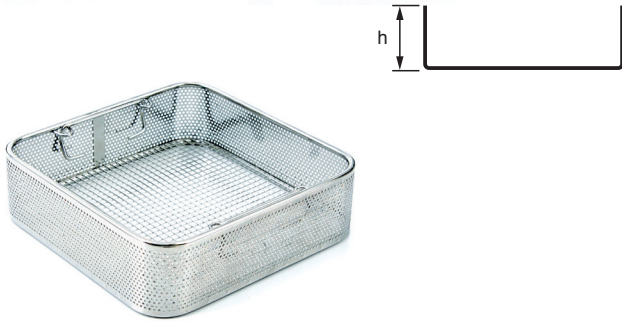
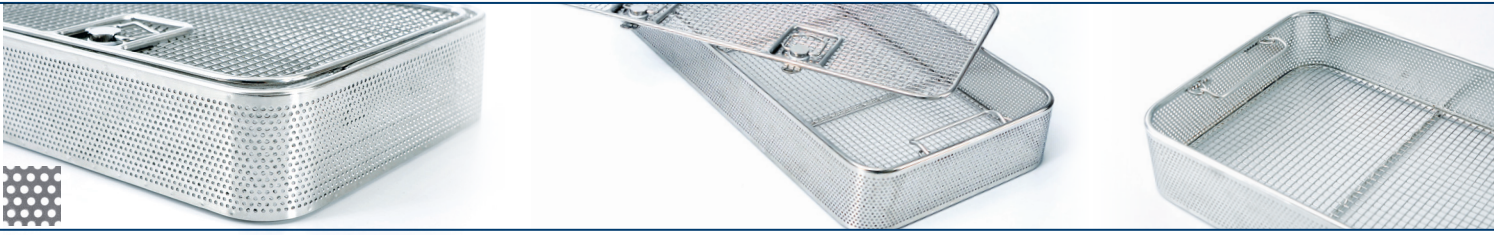

<b>ST5584</b>	255 x 250 x 50 mm
<b>ST5585</b>	255 x 250 x 70 mm
<b>ST5586</b>	255 x 250 x 100 mm
<b>ST5587</b>	Deckel allein, für Wanne only lid, for basket

Siebkorb 1/2  
wire basket 1/2

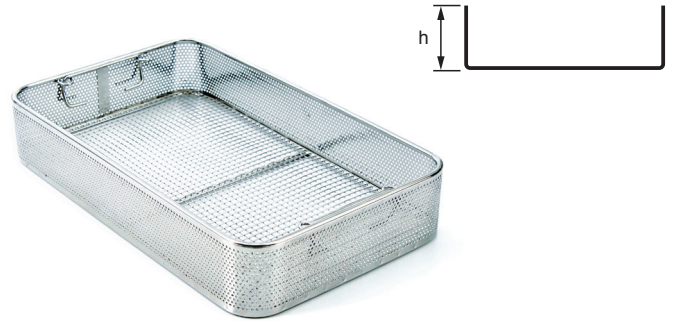

<b>ST5684</b>	405 x 250 x 50 mm
<b>ST5685</b>	405 x 250 x 70 mm
<b>ST5686</b>	405 x 250 x 100 mm
<b>ST5687</b>	Deckel allein, für Wanne only lid, for basket

Siebkorb 3/4  
wire basket 3/4

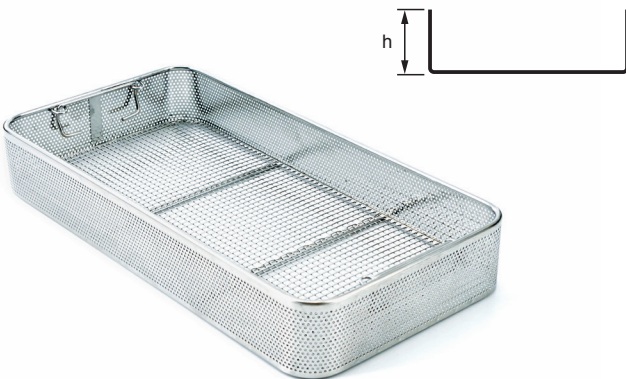

<b>ST5817</b>	480 x 250 x 50 mm
<b>ST5818</b>	480 x 250 x 70 mm
<b>ST5819</b>	480 x 250 x 100 mm
<b>ST5821</b>	Deckel allein, für Wanne only lid, for basket





Siebkorb 1/1  
wire basket 1/1

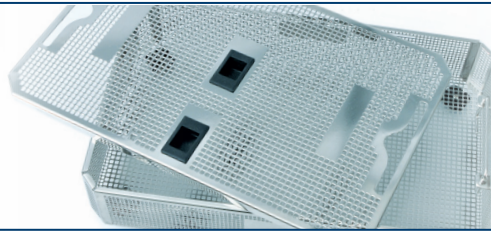

<b>ST5814</b>	540 x 250 x 50 mm
<b>ST5815</b>	540 x 250 x 70 mm
<b>ST5816</b>	540 x 250 x 100 mm
<b>ST5820</b>	Deckel allein, für Wanne only lid, for basket

Siebkorb 1/1 lang  
wire basket 1/1 long

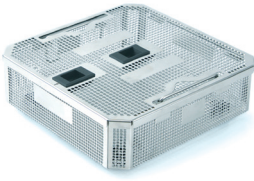
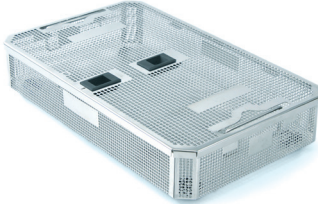
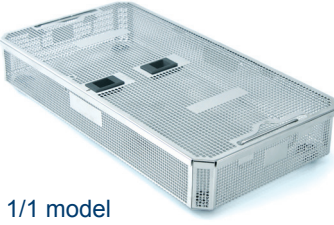
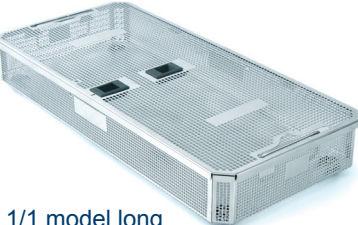
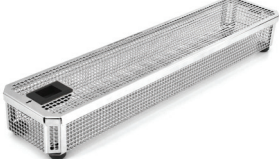

						
		h=1 (mm)	h=2 (mm)	Wanne und Deckel bottom and lid	Wanne bottom	Deckel lid
250 x 259 x h for 1/2 model		40 mm	44 mm	<b>ST5006-1</b>	<b>ST5009</b>	<b>ST5012</b>
		60 mm	64 mm	<b>ST5006</b>	<b>ST5010</b>	
		80 mm	84 mm	<b>ST5007</b>	<b>ST5011</b>	
		110 mm	114 mm	<b>ST5008</b>	<b>ST5011-1</b>	
411 x 259 x h for 3/4 model		40 mm	44 mm	<b>ST5030</b>	<b>ST5034</b>	<b>ST5038</b>
		60 mm	64 mm	<b>ST5031</b>	<b>ST5035</b>	
		80 mm	84 mm	<b>ST5032</b>	<b>ST5036</b>	
		110 mm	114 mm	<b>ST5033</b>	<b>ST5037</b>	
491 x 259 x h for 1/1 model		40 mm	44 mm	<b>ST5021</b>	<b>ST5025</b>	<b>ST5029</b>
		60 mm	64 mm	<b>ST5022</b>	<b>ST5026</b>	
		80 mm	84 mm	<b>ST5023</b>	<b>ST5027</b>	
		110 mm	114 mm	<b>ST5024</b>	<b>ST5028</b>	
546 x 259 x h for 1/1 model long		40 mm	44 mm	<b>ST5040</b>	<b>ST5044</b>	<b>ST5048</b>
		60 mm	64 mm	<b>ST5041</b>	<b>ST5045</b>	
		80 mm	84 mm	<b>ST5042</b>	<b>ST5046</b>	
		110 mm	114 mm	<b>ST5043</b>	<b>ST5047</b>	
492 x 134 x h for endo model		-	55 mm	<b>ST5110</b>	-	-

Siebkorb (mit Fuß)  
wire basket (with stand)

# Siebkörbe wire baskets

		h=1 (mm)	h=2 (mm)	Wanne und Deckel bottom and lid	Wanne bottom	Deckel lid
671 x 259 x h for extra long model 		40 mm	44 mm	<b>ST4859</b>	<b>ST4863</b>	<b>ST4867</b>
		60 mm	64 mm	<b>ST4860</b>	<b>ST4864</b>	
		80 mm	84 mm	<b>ST4861</b>	<b>ST4865</b>	
		110 mm	114 mm	<b>ST4862</b>	<b>ST4866</b>	
539 x 346 x h for MAGNUM 		40 mm	44 mm	<b>ST4850</b>	<b>ST4854</b>	<b>ST4858</b>
		60 mm	64 mm	<b>ST4851</b>	<b>ST4855</b>	
		80 mm	84 mm	<b>ST4852</b>	<b>ST4856</b>	
		110 mm	114 mm	<b>ST4853</b>	<b>ST4857</b>	
265 x 125 x h for small model 		60 mm	63 mm	<b>ST5055</b>	<b>ST5056</b>	<b>ST5057</b>
275 x 175 x h for dental model 		45 mm	53 mm	<b>ST5014-01</b>	<b>ST5014-02</b>	<b>ST5014-05</b>
		105 mm	113 mm	<b>ST5014-03</b>	<b>ST5014-04</b>	
320 x 220 x h for large dental model 		60 mm	63 mm	<b>ST4877</b>	<b>ST4880</b>	<b>ST4883</b>
		80 mm	83 mm	<b>ST4878</b>	<b>ST4881</b>	
		110 mm	113 mm	<b>ST4879</b>	<b>ST4882</b>	

Siebkorb (mit Fuß)  
wire basket (with stand)



**ST5075** 20 mm Höhe, height

Fuß  
stand

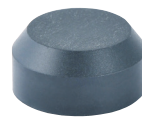

**ST5076** 14 mm Höhe, height

Fuß  
stand



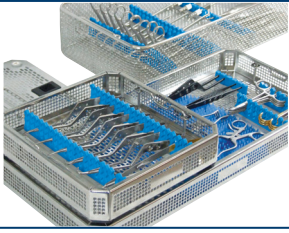

	Länge length	Breite width	Höhe height
<b>ST4885</b>	250 mm	18 mm	9 mm
<b>ST4886</b>	158 mm	18 mm	9 mm
<b>ST4887</b>	123 mm	18 mm	9 mm
<b>ST4888</b>	97 mm	18 mm	9 mm
<b>ST4889</b>	73 mm	18 mm	9 mm
<b>ST4890</b>	23,5 mm	18 mm	9 mm

Schiene  
rail



**ST4891**

1 Stück  
1 piece

Mutter  
keep nut



**ST4892**

1 Stück  
1 piece

Schraube  
screw

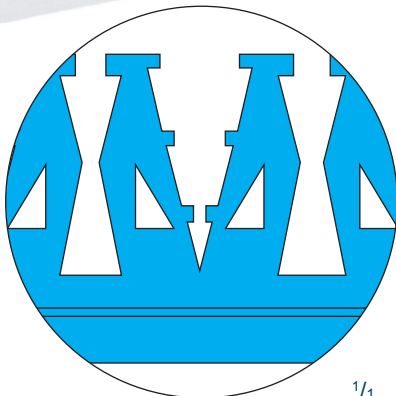
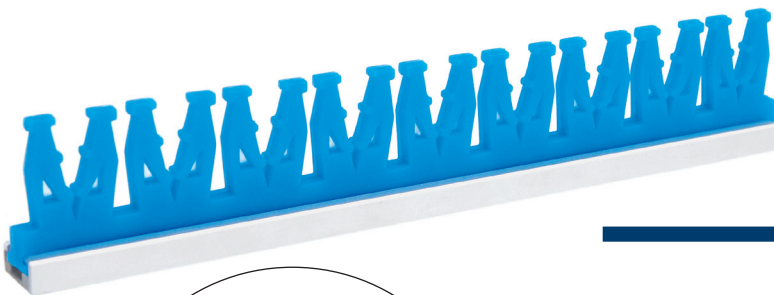

1/1

	Länge length	Höhe height	passend ab Siebkorb Höhe fitting wire basket height
<b>ST4893</b>	250 mm	45 mm	70 mm
<b>ST4894</b>	152 mm	45 mm	70 mm
<b>ST4895</b>	125 mm	45 mm	70 mm
<b>ST4896</b>	97 mm	45 mm	70 mm

mit Schiene, Schraube und Mutter  
with rail, screw and nut

# Silikonbefestigungssystem silicone fixation system

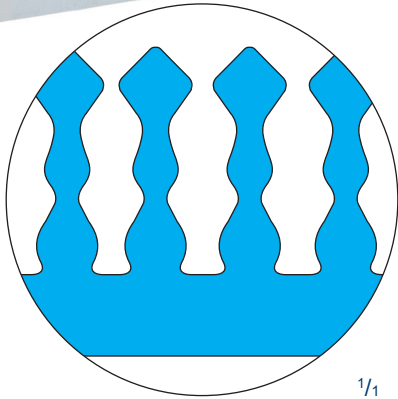
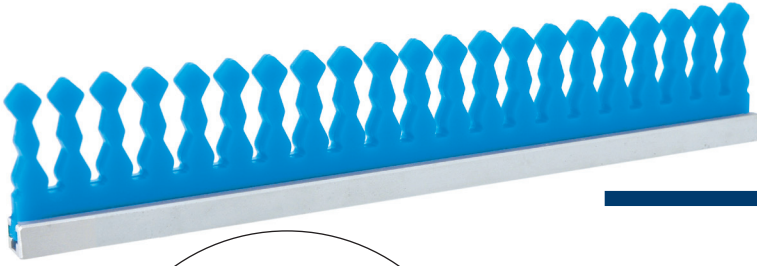

1/1

	Länge length	Höhe height	passend ab Siebkorb Höhe fitting wire basket height
<b>ST5064</b>	238 mm	45 mm	70 mm
<b>ST5065</b>	158 mm	45 mm	70 mm
<b>ST5066</b>	112 mm	45 mm	70 mm
<b>ST5067</b>	77 mm	45 mm	70 mm

mit Schiene, Schraube und Mutter  
with rail, screw and nut

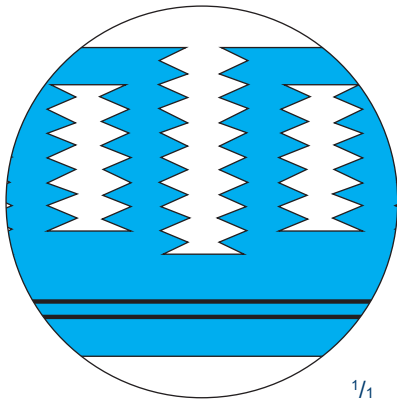

1/1

	Länge length	Höhe height	passend ab Siebkorb Höhe fitting wire basket height
<b>ST5060</b>	238 mm	45 mm	70 mm
<b>ST5061</b>	150 mm	45 mm	70 mm
<b>ST5062</b>	119 mm	45 mm	70 mm
<b>ST5063</b>	87 mm	45 mm	70 mm

mit Schiene, Schraube und Mutter  
with rail, screw and nut

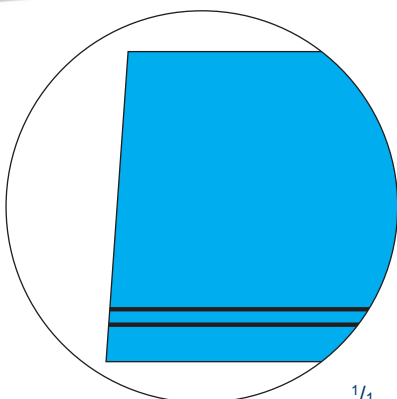

1/1

	Länge length	Höhe height	passend ab Siebkorb Höhe fitting wire basket height
<b>ST5070</b>	240 mm	45 mm	70 mm
<b>ST5071</b>	150 mm	45 mm	70 mm
<b>ST5072</b>	120 mm	45 mm	70 mm
<b>ST5073</b>	90 mm	45 mm	70 mm

mit Schiene, Schraube und Mutter  
with rail, screw and nut

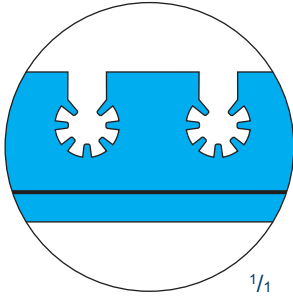

	Länge	Höhe	passend ab Siebkorb Höhe
	length	height	fitting wire basket height
<b>ST5080</b>	178 mm	24 mm	30 mm

Instrumentenhalter, von Ø 3 bis 8 mm  
mit Schiene, Schraube und Mutter  
instruments holder, from Ø 3 to 8 mm  
with rail, screw and nut

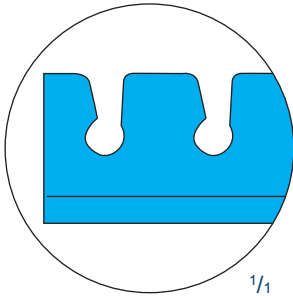

	Länge	Höhe	passend ab Siebkorb Höhe
	length	height	fitting wire basket height
<b>ST5082</b>	73 mm	24 mm	30 mm

Instrumentenhalter, Ø 5 mm  
mit Schiene, Schraube und Mutter  
instruments holder, Ø 5 mm  
with rail, screw and nut

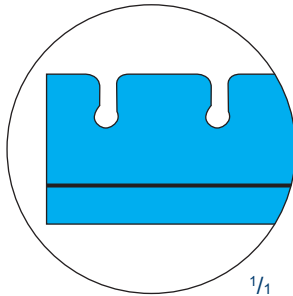

	Länge	Höhe	passend ab Siebkorb Höhe
	length	height	fitting wire basket height
<b>ST4897</b>	73 mm	24 mm	30 mm

Instrumentenhalter, Ø 3 mm  
mit Schiene, Schraube und Mutter  
instruments holder, Ø 3 mm  
with rail, screw and nut

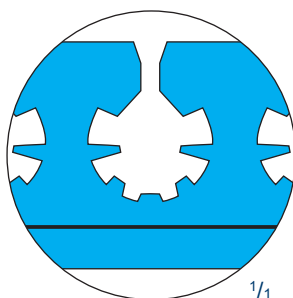

	Länge	Höhe	passend ab Siebkorb Höhe
	length	height	fitting wire basket height
<b>ST4898</b>	178 mm	34 mm	50 mm

Instrumentenhalter, von Ø 3 bis 15 mm  
mit Schiene, Schraube und Mutter  
instruments holder, from Ø 3 to 15 mm  
with rail, screw and nut

# Silikonbefestigungssystem silicone fixation system

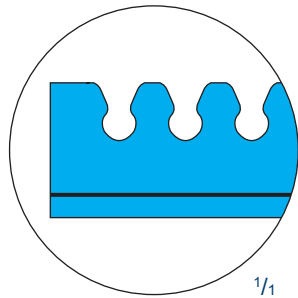

1/1

	Länge	Höhe	passend ab Siebkorb Höhe
	length	height	fitting wire basket height
<b>ST5084</b>	121 mm	22 mm	30 mm

mit Schiene, Schraube und Mutter  
with rail, screw and nut

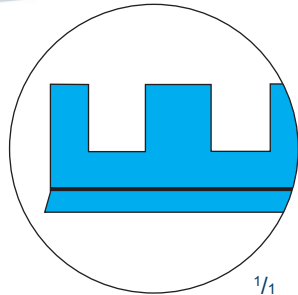
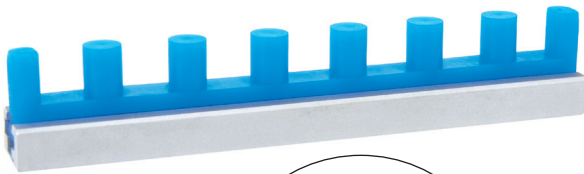

1/1

	Länge	Höhe	passend ab Siebkorb Höhe
	length	height	fitting wire basket height
<b>ST5086</b>	123 mm	22 mm	30 mm

mit Schiene, Schraube und Mutter  
with rail, screw and nut

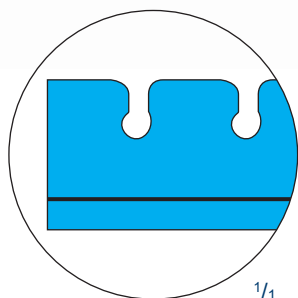

1/1

	Länge	Höhe	passend ab Siebkorb Höhe
	length	height	fitting wire basket height
<b>ST4899</b>	178 mm	24 mm	30 mm

Instrumentenhalter, von Ø 3 mm  
mit Schiene, Schraube und Mutter  
instruments holder, from Ø 3 mm  
with rail, screw and nut

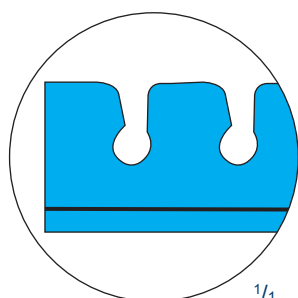

1/1

	Länge	Höhe	passend ab Siebkorb Höhe
	length	height	fitting wire basket height
<b>ST4900</b>	178 mm	24 mm	30 mm

Instrumentenhalter, von Ø 5 mm  
mit Schiene, Schraube und Mutter  
instruments holder, from Ø 5 mm  
with rail, screw and nut



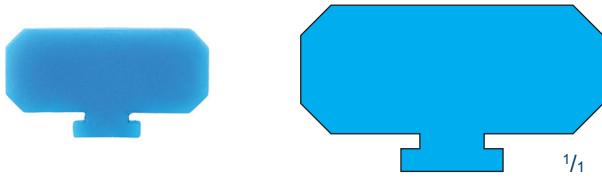

	Länge	Höhe	passend ab Siebkorb Höhe
	length	height	fitting wire basket height
<b>ST4901</b>	40 mm	22 mm	30 mm

mit Schiene, Schraube und Mutter  
with rail, screw and nut

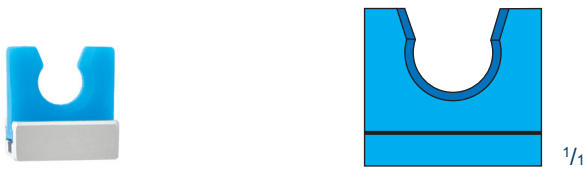

	Länge	Höhe	passend ab Siebkorb Höhe
	length	height	fitting wire basket height
<b>ST4902</b>	23,5 mm	25 mm	50 mm

Ø 10,5 mm  
mit Schiene, Schraube und Mutter  
Ø 10,5 mm  
with rail, screw and nut



	Länge	Höhe	passend ab Siebkorb Höhe
	length	height	fitting wire basket height
<b>ST4903</b>	23,5 mm	25 mm	50 mm

Ø 8 mm  
mit Schiene, Schraube und Mutter  
Ø 8 mm  
with rail, screw and nut



	Länge	Höhe	passend ab Siebkorb Höhe
	length	height	fitting wire basket height
<b>ST4904</b>	23,5 mm	25 mm	50 mm

Ø 13 mm  
mit Schiene, Schraube und Mutter  
Ø 13 mm  
with rail, screw and nut



	Länge	Höhe	passend ab Siebkorb Höhe
	length	height	fitting wire basket height
<b>ST4905</b>	23,5 mm	25 mm	50 mm

Ø 5 mm  
mit Schiene, Schraube und Mutter  
Ø 5 mm  
with rail, screw and nut

# Silikonbefestigungssystem silicone fixation system

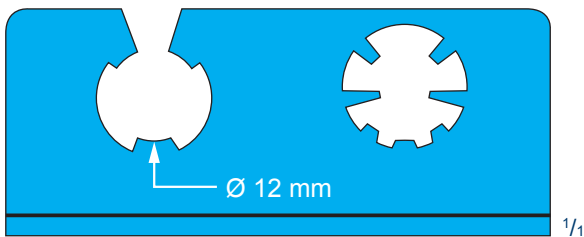

	Länge	Höhe	passend ab Siebkorb Höhe
	length	height	fitting wire basket height
<b>ST4906</b>	72 mm	34 mm	50 mm

Endoskopiehalter, doppelt, 1 Seite Ø 12 mm offen,  
1 Seite von Ø 3 bis Ø 15 mm geschlossen,  
mit Schiene, Schraube und Mutter  
endoscope holder, double, one side Ø 12 mm open, one side  
from Ø 3 to Ø 15 mm closed,  
with rail, screw and nut

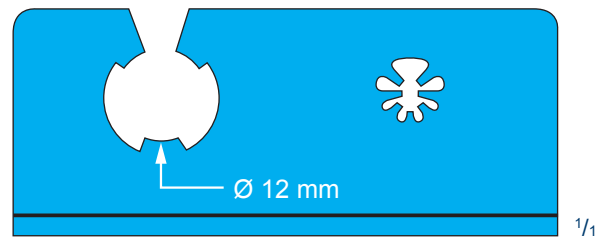

	Länge	Höhe	passend ab Siebkorb Höhe
	length	height	fitting wire basket height
<b>ST4907</b>	72 mm	34 mm	50 mm

Endoskopiehalter, doppelt, 1 Seite Ø 12 mm offen,  
1 Seite von Ø 3 bis Ø 8 mm geschlossen,  
mit Schiene, Schraube und Mutter  
endoscope holder, double, one side Ø 12 mm open, one side  
from Ø 3 to Ø 8 mm closed,  
with rail, screw and nut

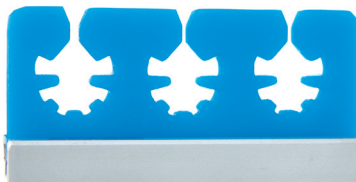
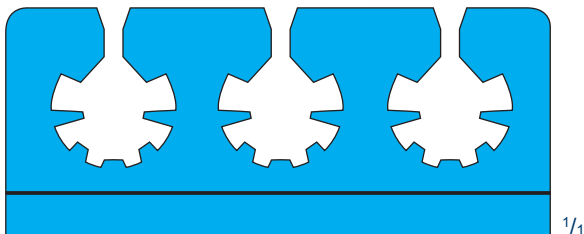

	Länge	Höhe	passend ab Siebkorb Höhe
	length	height	fitting wire basket height
<b>ST4908</b>	72 mm	34 mm	50 mm

Instrumentenhalter,  
von Ø 3 bis Ø 15 mm,  
mit Schiene, Schraube und Mutter  
instruments holder,  
from Ø 3 to Ø 15 mm,  
with rail, screw and nut

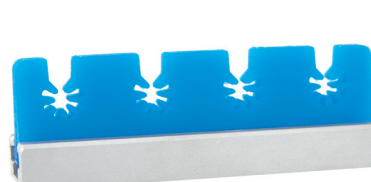
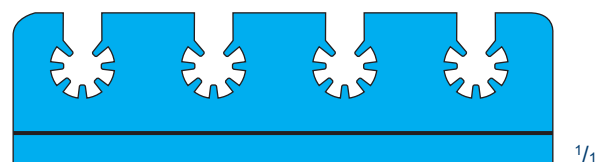

	Länge	Höhe	passend ab Siebkorb Höhe
	length	height	fitting wire basket height
<b>ST4909</b>	72 mm	24 mm	30 mm

Instrumentenhalter,  
von Ø 3 bis Ø 8 mm,  
mit Schiene, Schraube und Mutter  
instruments holder,  
from Ø 3 to Ø 8 mm,  
with rail, screw and nut

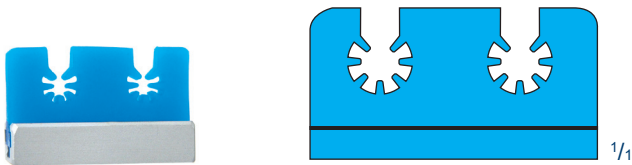

	Länge length	Höhe height	passend ab Siebkorb Höhe fitting wire basket height
<b>ST4910</b>	38 mm	24 mm	30 mm

Endoskopiehalter, doppelt,  
1 Seite von Ø 3 bis Ø 8 mm,  
mit Schiene, Schraube und Mutter  
endoscope holder, double,  
one side from Ø 3 to Ø 8 mm  
with rail, screw and nut

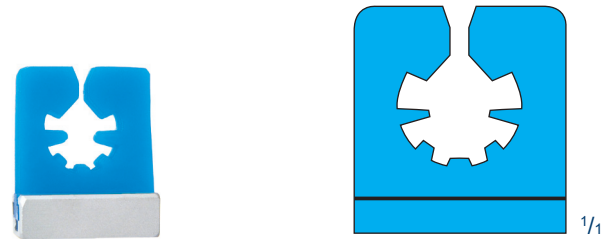

	Länge length	Höhe height	passend ab Siebkorb Höhe fitting wire basket height
<b>ST4911</b>	28 mm	34 mm	50 mm

Endoskopiehalter, einzeln, 1 Seite Ø 12 mm offen,  
1 Seite von Ø 3 bis Ø 15 mm,  
mit Schiene, Schraube und Mutter  
endoscope holder, single, one side Ø 12 mm open,  
one side from Ø 3 to Ø 15 mm  
with rail, screw and nut

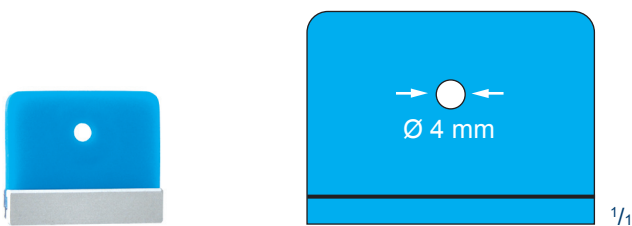

	Länge length	Höhe height	passend ab Siebkorb Höhe fitting wire basket height
<b>ST4912</b>	38 mm	33 mm	50 mm

Endoskopiehalter, Ø 4 mm geschlossen  
mit Schiene, Schraube und Mutter  
endoscope holder, Ø 4 mm closed,  
with rail, screw and nut

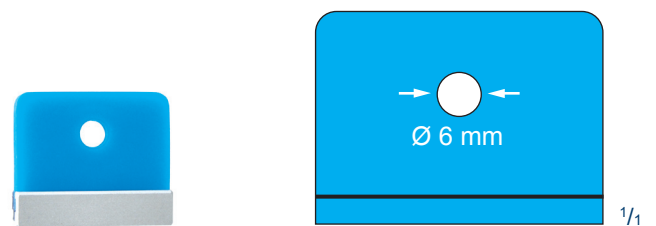

	Länge length	Höhe height	passend ab Siebkorb Höhe fitting wire basket height
<b>ST4913</b>	38 mm	33 mm	50 mm

Endoskopiehalter, Ø 6 mm geschlossen  
mit Schiene, Schraube und Mutter  
endoscope holder, Ø 6 mm closed,  
with rail, screw and nut

# Silikonbefestigungssystem silicone fixation system

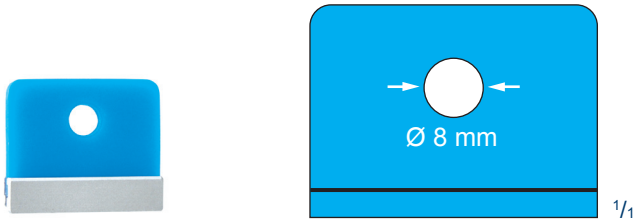

	Länge length	Höhe height	passend ab Siebkorb Höhe fitting wire basket height
<b>ST4914</b>	38 mm	33 mm	50 mm

Endoskopiehalter, Ø 8 mm geschlossen  
mit Schiene, Schraube und Mutter  
endoscope holder, Ø 8 mm closed,  
with rail, screw and nut

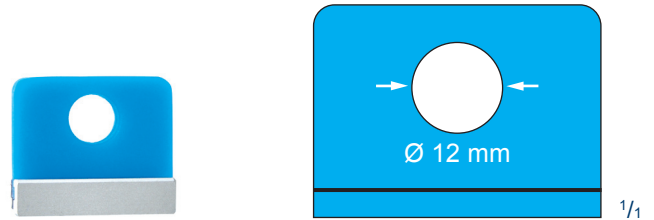

	Länge length	Höhe height	passend ab Siebkorb Höhe fitting wire basket height
<b>ST4915</b>	38 mm	33 mm	50 mm

Endoskopiehalter, Ø 12 mm geschlossen  
mit Schiene, Schraube und Mutter  
endoscope holder, Ø 12 mm closed,  
with rail, screw and nut

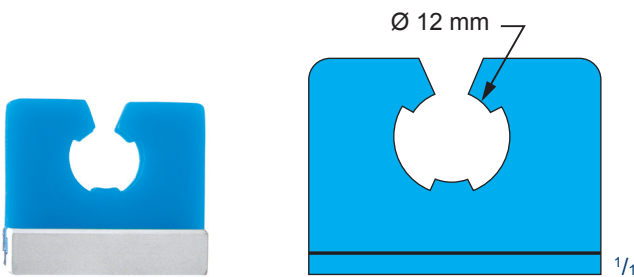

	Länge length	Höhe height	passend ab Siebkorb Höhe fitting wire basket height
<b>ST4916</b>	38 mm	33 mm	50 mm

Endoskopiehalter, Ø 12 mm offen  
mit Schiene, Schraube und Mutter  
endoscope holder, Ø 12 mm open,  
with rail, screw and nut

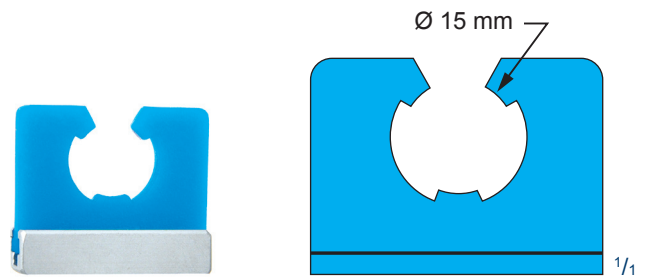

	Länge length	Höhe height	passend ab Siebkorb Höhe fitting wire basket height
<b>ST4917</b>	38 mm	33 mm	50 mm

Endoskopiehalter, Ø 15 mm offen  
mit Schiene, Schraube und Mutter  
endoscope holder, Ø 15 mm open,  
with rail, screw and nut

- 100% Wärmeverteilung und Temperaturabgabe der Sterilisationstemperaturen auf Instrumentenoberflächen an Lager- und Fixationsstellen
- hohe Spülkraft durch großes Karomuster
- geringe Kontaktfläche zwischen Instrument und Halter
- optionales Spülergebnis
- geringes Gewicht
- individuell nach Kundenwunsch kombinierbar
- Spezialtrays für Kamerasysteme, Optiken, Implantate, Mikroinstrumente, Kleinteile, Klapptrays für Allgemeininstrumentarium
- einfaches und stabiles Verschlussystem
- Anschluss für Innenspüladapter und Hohlinstrumente
- keine Wiederbeschaffungskosten für Silikon
- kurze Amortisationszeit
- hohe Lebensdauer
- federnde Halterung für sichere Instrumentenlagerung
- passend in Sterilcontainer

- 100% heat distribution and temperature output of sterilization temperatures on instrument surfaces at storage and fixation sites
- high cleaning power through large cross grids
- small contact surface between instrument and holder
- optional rinsing result
- low weight
- individually combinable according to customer requirements
- special trays for camera systems, optics, implants, micro-instruments, small items, foldable trays for general instruments
- easy and solid locking system
- connection for internal flushing adapter and hollow instruments
- no replacement costs for silicone
- fast amortization
- longlife
- resilient holder for secure instrument storage
- suitable for sterile containers

2 x Federhalterung  
spring retainer  
4 x Alligatorhalter  
alligator holder



3 x Federhalter  
spring retainer  
6 x Alligatorhalter  
alligator holder



<b>ST0110</b>	243 x 253 x 24 mm
<b>ST0111</b>	243 x 253 x 36 mm
<b>ST0112</b>	243 x 253 x 44 mm
<b>ST0113</b>	243 x 253 x 56 mm
<b>ST0114</b>	243 x 253 x 64 mm
<b>ST0115</b>	243 x 253 x 76 mm
<b>ST0116</b>	243 x 253 x 94 mm
<b>ST0117</b>	243 x 253 x 106 mm

Quick Fix Standard Siebkorb 1/2  
Quick Fix standard tray 1/2

<b>ST0120</b>	406 x 252 x 24 mm
<b>ST0121</b>	406 x 252 x 36 mm
<b>ST0122</b>	406 x 252 x 44 mm
<b>ST0123</b>	406 x 252 x 56 mm
<b>ST0124</b>	406 x 252 x 64 mm
<b>ST0125</b>	406 x 252 x 76 mm
<b>ST0126</b>	406 x 252 x 94 mm
<b>ST0127</b>	406 x 252 x 106 mm

Quick Fix Standard Siebkorb 3/4  
Quick Fix standard tray 3/4

# Quick Fix Siebkörbe

## Quick Fix trays

3 x Federhalter  
spring retainer  
6 x Alligatorhalter  
alligator holder

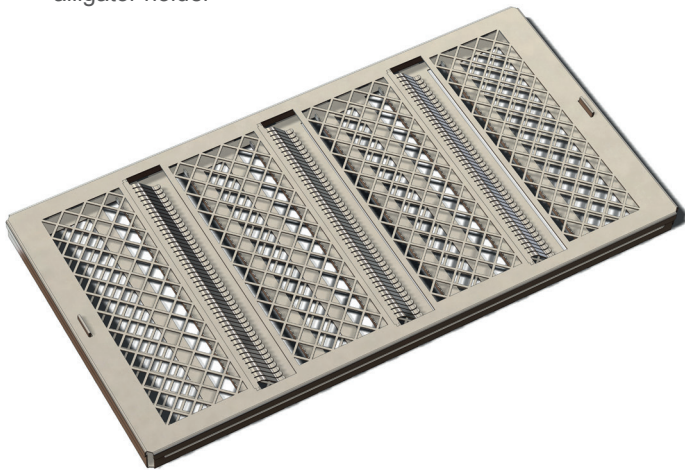

<b>ST0130</b>	485 x 253 x 24 mm
<b>ST0131</b>	485 x 253 x 36 mm
<b>ST0132</b>	485 x 253 x 44 mm
<b>ST0133</b>	485 x 253 x 56 mm
<b>ST0134</b>	485 x 253 x 64 mm
<b>ST0135</b>	485 x 253 x 76 mm
<b>ST0136</b>	485 x 253 x 94 mm
<b>ST0137</b>	485 x 253 x 106 mm

Quick Fix Standard Siebkorb  
Quick Fix standard tray

4 x Federhalter  
spring retainer  
8 x Alligatorhalter  
alligator holder



<b>ST0140</b>	536 x 252 x 24 mm
<b>ST0141</b>	536 x 252 x 36 mm
<b>ST0142</b>	536 x 252 x 44 mm
<b>ST0143</b>	536 x 252 x 56 mm
<b>ST0144</b>	536 x 252 x 64 mm
<b>ST0145</b>	536 x 252 x 76 mm
<b>ST0146</b>	536 x 252 x 94 mm
<b>ST0147</b>	536 x 252 x 106 mm

Quick Fix Standard Siebkorb 1/1  
Quick Fix standard tray 1/1

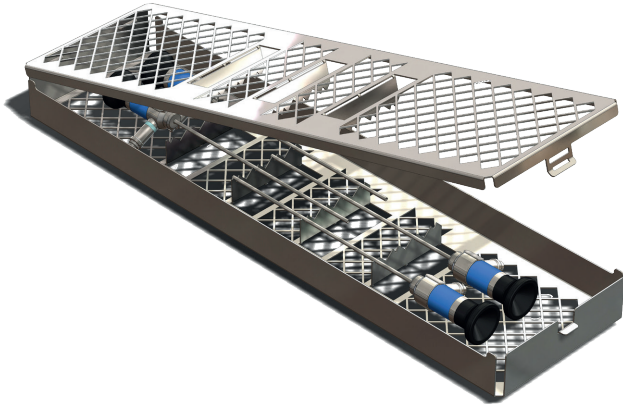

<b>ST0152-1</b>	300 x 84 x 41 mm
<b>ST0150</b>	454 x 84 x 41 mm
<b>ST0151</b>	454 x 104 x 41 mm
<b>ST0152</b>	501 x 134 x 45 mm

Mit integrierter Innenspüladapteraussparung zur optimalen Reinigung von Hohlkörperinstrumenten.  
Für alle Adapter verfügbar.  
With integrated inner flushing adapter recess for optimal cleaning of hollow body instruments.  
Available for all adapters.

Quick Fix Optik Korb  
Quick Fix optic tray

1 x Federhalter  
spring retainer  
2 x Alligatorhalter  
alligator holder



<b>ST0153</b>	273 x 176 x 41 mm
<b>ST0154</b>	273 x 176 x 30 mm

Quick Fix Spezialsiebkorb  
Längshalterung für 25 Instrumente  
Quick Fix special tray  
fixation for 25 instruments

# Quick Fix Siebkörbe

## Quick Fix trays

1 x Federhalter  
spring retainer



2 x Alligatorhalter  
alligator holder

<b>ST0155</b>	85 x 44 x 20 mm
<b>ST0156</b>	85 x 44 x 25 mm
<b>ST0157</b>	145 x 44 x 25 mm
<b>ST0158</b>	354 x 44 x 35 mm
<b>ST0159</b>	135 x 120 x 47 mm
<b>ST0160</b>	235 x 137 x 42 mm
<b>ST0161</b>	267 x 125 x 49 mm
<b>ST0162</b>	273 x 176 x 60 mm
<b>ST0163</b>	269 x 171 x 93 mm
<b>ST0164</b>	273 x 176 x 20 mm
<b>ST0165</b>	273 x 84 x 41 mm
<b>ST0166</b>	273 x 176 x 30 mm
<b>ST0167</b>	236 x 72 x 27 mm
<b>ST0168</b>	273 x 84 x 30 mm
<b>ST0169</b>	188 x 125 x 30 mm

Quick Fix Spezial Siebkorb  
Quick Fix special tray



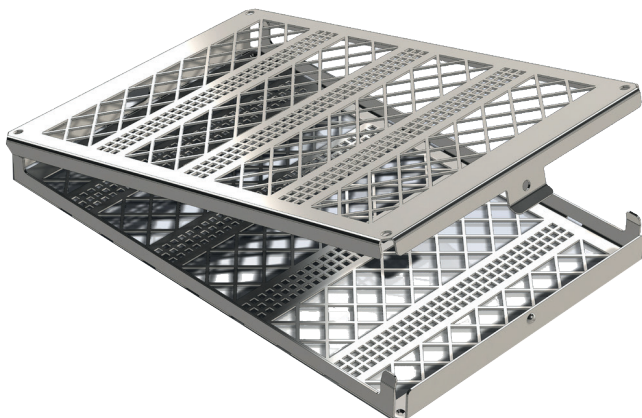

Quadratlochstreifen mit 4 x 4 mm Lochung im Boden.  
Square perforated strips with 4 x 4 mm holes in the bottom.

<b>ST0174</b>	243 x 253 x 24 mm
<b>ST0175</b>	243 x 253 x 36 mm
<b>ST0176</b>	243 x 253 x 44 mm
<b>ST0177</b>	243 x 253 x 56 mm
<b>ST0178</b>	243 x 253 x 64 mm
<b>ST0179</b>	243 x 253 x 76 mm
<b>ST0180</b>	243 x 253 x 94 mm
<b>ST0181</b>	243 x 253 x 106 mm

Quick Fix Universal 1/2  
Quick Fix universal 1/2

<b>ST0182</b>	406 x 253 x 24 mm
<b>ST0183</b>	406 x 253 x 36 mm
<b>ST0184</b>	406 x 253 x 44 mm
<b>ST0185</b>	406 x 253 x 56 mm
<b>ST0186</b>	406 x 253 x 64 mm
<b>ST0187</b>	406 x 253 x 76 mm
<b>ST0188</b>	406 x 253 x 94 mm
<b>ST0189</b>	406 x 253 x 106 mm

Quick Fix Universal 3/4  
Quick Fix universal 3/4

<b>ST0190</b>	485 x 253 x 24 mm
<b>ST0191</b>	485 x 253 x 36 mm
<b>ST0192</b>	485 x 253 x 44 mm
<b>ST0193</b>	485 x 253 x 56 mm
<b>ST0194</b>	485 x 253 x 64 mm
<b>ST0195</b>	485 x 253 x 76 mm
<b>ST0196</b>	485 x 253 x 94 mm
<b>ST0197</b>	485 x 253 x 106 mm

Quick Fix Universal 1/1  
Quick Fix universal 1/1

<b>ST0198</b>	536 x 252 x 24 mm
<b>ST0199</b>	536 x 252 x 36 mm
<b>ST0200</b>	536 x 252 x 44 mm
<b>ST0201</b>	536 x 252 x 56 mm
<b>ST0202</b>	536 x 252 x 64 mm
<b>ST0203</b>	536 x 252 x 76 mm
<b>ST0204</b>	536 x 252 x 94 mm
<b>ST0205</b>	536 x 252 x 106 mm

Quick Fix Universal  
Quick Fix universal

<b>ST0170</b>	662 x 254 x 56 mm
<b>ST0171</b>	662 x 254 x 120 mm
<b>ST0172</b>	662 x 254 x 160 mm
<b>ST0173</b>	662 x 254 x 200 mm

Quick Fix XXL tray  
Quick Fix XXL tray

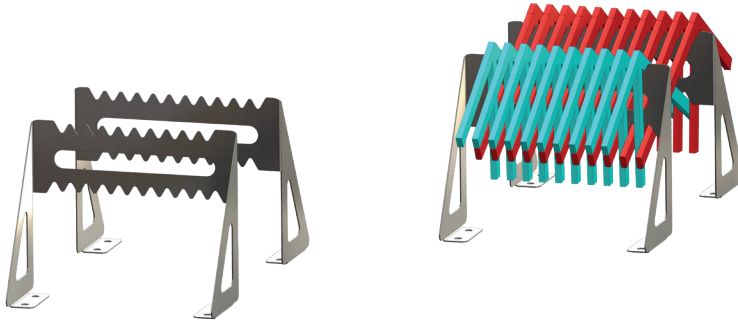

Alligatorhalterung  
alligator holder

**ST0206**

für Traybreite 250 mm,  
Höhe 150 mm  
for tray width 250 mm,  
height 150 mm

Quick Fix Lagerungsrack für Standard 1/1  
Quick Fix storage rack for standard 1/1

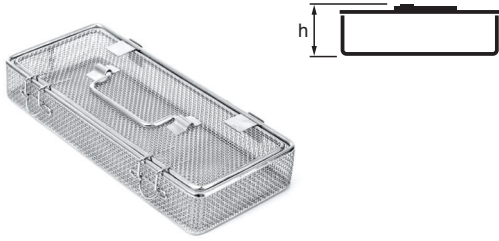

**ST5383** 265 x 125 x 50 mm

Siebkorb mit Deckel, Mini Modell  
wire basket with lid, mini model

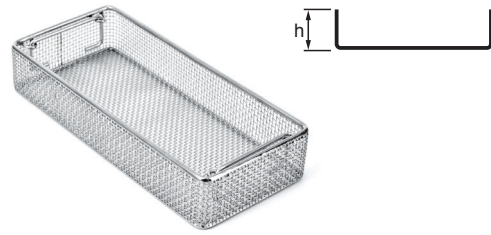

**ST5381** 265 x 125 x 50 mm

Siebkorb für Mini Modell  
wire basket for mini model

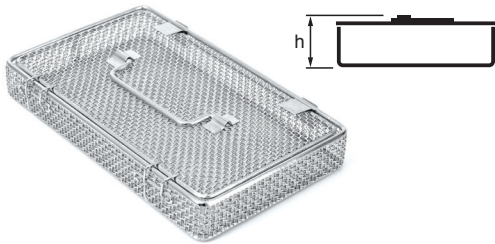

**ST5253** 270 x 175 x 45 mm

Siebkorb mit Deckel, Dental Modell  
wire basket with lid, dental model

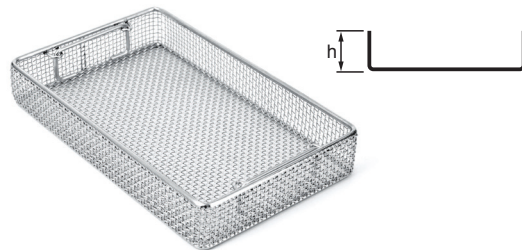

**ST5251** 265 x 175 x 50 mm

Siebkorb für Dental Container  
wire basket for dental container

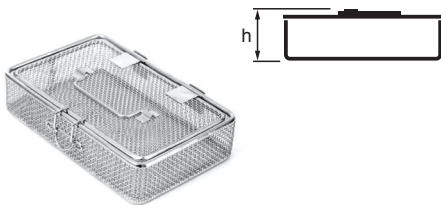

**ST5257** 170 x 140 x 45 mm

Siebkorb mit Deckel, 1/2 Dental Modell  
wire basket with lid, 1/2 dental model

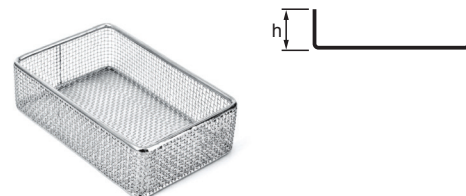

**ST5258** 170 x 140 x 45 mm

Siebkorb für 1/2 Dental Modell  
wire basket for 1/2 dental model

## Dental- und Minikörbe dental and mini baskets

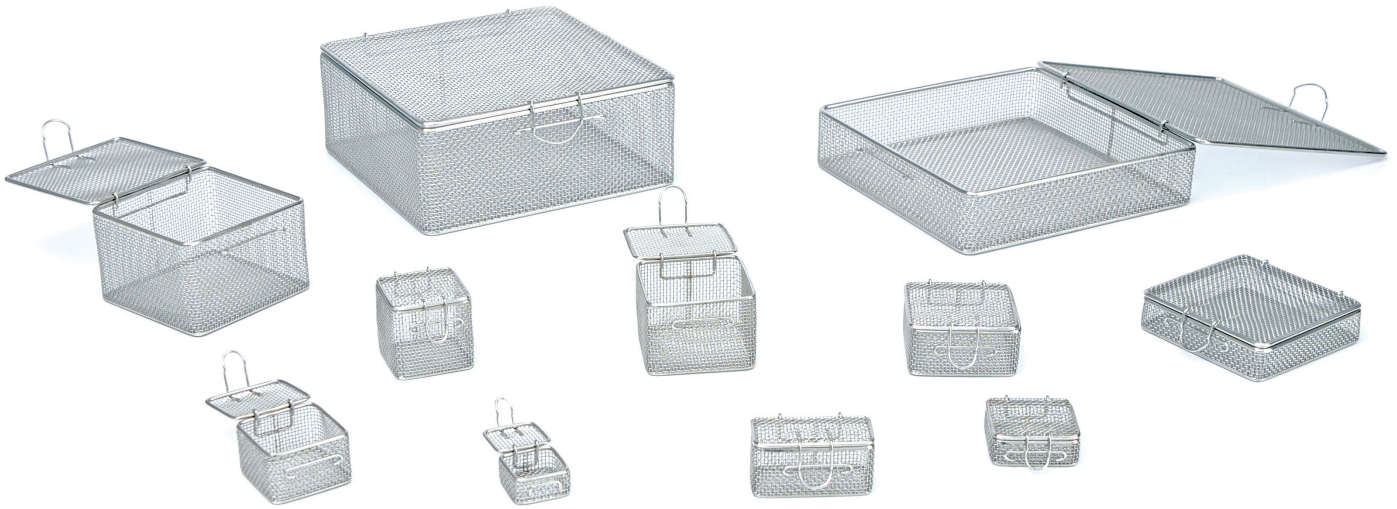

<b>ST0280</b>	30 x 30 x 30 mm
<b>ST0281</b>	40 x 40 x 20 mm
<b>ST0282</b>	40 x 40 x 40 mm
<b>ST0283</b>	60 x 60 x 20 mm
<b>ST0284</b>	60 x 60 x 40 mm
<b>ST0285</b>	60 x 60 x 60 mm
<b>ST0286</b>	80 x 80 x 20 mm
<b>ST0287</b>	80 x 40 x 40 mm
<b>ST0288</b>	80 x 80 x 40 mm
<b>ST0289</b>	80 x 80 x 60 mm
<b>ST0290</b>	80 x 80 x 80 mm

kleiner Drahtsiebkorb mit Deckel  
small fine mesh basket with lid

<b>ST0291</b>	100 x 100 x 10 mm
<b>ST0292</b>	120 x 120 x 30 mm
<b>ST0293</b>	120 x 120 x 60 mm
<b>ST0294</b>	120 x 120 x 80 mm
<b>ST0295</b>	240 x 240 x 30 mm
<b>ST0296</b>	240 x 240 x 60 mm
<b>ST0297</b>	240 x 240 x 80 mm
<b>ST0298</b>	240 x 240 x 100 mm

kleiner Drahtsiebkorb mit Deckel  
small fine mesh basket with lid



<b>ST0510</b>	670 x 80 x 52 mm
---------------	------------------

<b>ST0508</b>	460 x 80 x 52 mm
---------------	------------------

<b>ST0507</b>	290 x 80 x 52 mm
---------------	------------------

Siebkorb  
wire basket



<b>ST0500</b>	640 x 150 x 77 mm
---------------	-------------------

Siebkorb  
wire basket

## Rack rack

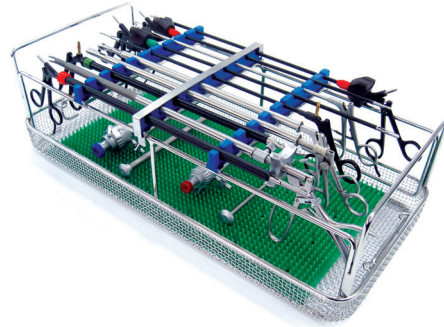
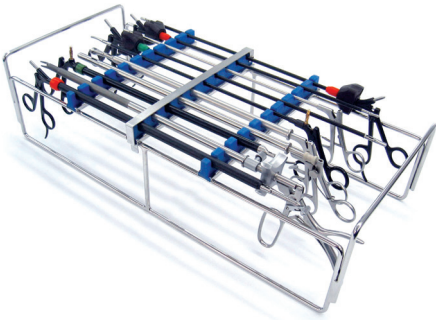

### ST5980

510 x 240 x 130 mm

Rack, für Endoskopie

- Halter für 10 Endoskopieinstrumente
- passt in einen 1/1 Container, 20 cm tief
- Siebkorb 1/1 50 mm
- Container 1/1 200 mm
- Silikonmatte 520 x 230 mm

rack, for endoscopy

- holds 10 endoscopy instruments
- fits into a 1/1 size 20 cm deep container
- wire basket 1/1 50 mm
- container 1/1 200 mm
- silicone mat 520 x 230 mm

### ST5981

550 x 240 x 130 mm

Rack, für Endoskopie

- Halter für 10 Endoskopieinstrumente
- passt in einen extra langen Container, 18 cm tief
- Siebkorb extra lang 50 mm
- Container extra lang 180 mm
- Silikonmatte 340 x 230 mm /2 Stück)

rack, for endoscopy

- holds 10 endoscopy instruments
- fits into an extra long size 18 cm deep container
- wire basket extra long 50 mm
- container extra long 180 mm
- silicone mat 340 x 230 mm (2 pcs)

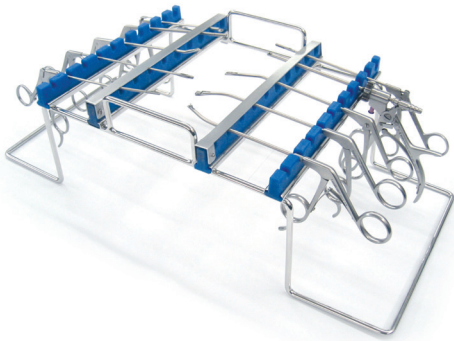

**ST5982**

515 x 240 x 165 mm

Rack, für Arthroskopie

- Halter für 20 Arthroskopie Stanzen
- passt in einen 1/1 Container, 20 cm tief
- Siebkorb 1/1 50 mm
- Container 1/1 200 mm
- Silikonmatte 440 x 230 mm

rack, for arthroscopy

- holds 20 arthroscopy punches
- fits into a 1/1 size 20 cm deep container
- wire basket 1/1 50 mm
- container 1/1 200 mm
- silicone mat 440 x 230 mm

## Rack rack

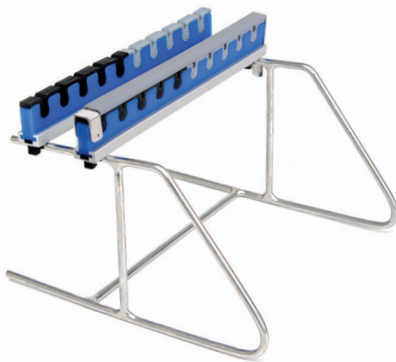
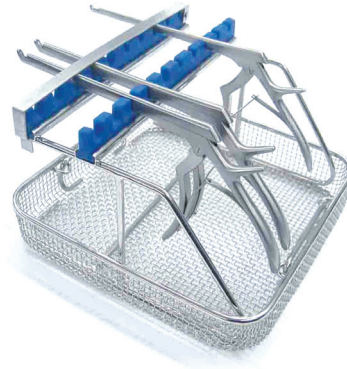

**ST5983**

225 x 245 x 160 mm

Rack, für KERRISON

- Halter für 20 KERRISON Stanzen
- passt in einen 1/2, 1/1 Container, 20 cm tief und extra lang Container, 18 cm tief
- Siebkorb 1/2 50 mm
- Siebkorb 1/1 50 mm
- Siebkorb extra lang 50 mm
- Container 1/2 200 mm
- Container 1/1 200 mm
- Container extra lang 180 mm

rack, for KERRISON

- holds 20 KERRISON punches
- fits into a 1/2, 1/1 size 20 cm and extra long size 18 cm deep container
- wire basket 1/2 50 mm
- wire basket 1/1 50 mm
- wire basket extra long 50 mm
- container 1/2 200 mm
- container 1/1 200 mm
- container extra long 180 mm





<b>ST0341</b>	600 x 400 x 150 mm
---------------	--------------------

<b>ST0342</b>	600 x 400 x 300 mm
---------------	--------------------

## LAUNDRY BASKET

Siebkorb  
wire basket



<b>ST0343</b>	600 x 400 x 150 mm
---------------	--------------------

<b>ST0344</b>	600 x 400 x 300 mm
---------------	--------------------

## LAUNDRY BASKET

Siebkorb  
wire basket



<b>ST0345</b>	250 x 170 x 70 mm
---------------	-------------------

<b>ST0346</b>	340 x 250 x 70 mm
---------------	-------------------

<b>ST0347</b>	450 x 340 x 70 mm
---------------	-------------------

## WIRE NET BASKET

Siebkorb  
wire basket

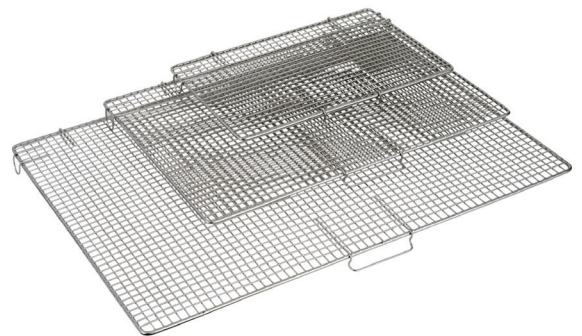

<b>ST0348</b>	250 x 170 mm
---------------	--------------

<b>ST0349</b>	340 x 250 mm
---------------	--------------

<b>ST0350</b>	450 x 340 mm
---------------	--------------

## LID FOR WIRE NET BASKET

Siebkorb  
wire basket



Standard

<b>ST0351</b>	575 x 280 x 135 mm
---------------	--------------------

<b>ST0352</b>	575 x 280 x 265 mm
---------------	--------------------

### STE BASKET

Siebkorb  
wire basket



front access

<b>ST0353</b>	575 x 280 x 265 mm
---------------	--------------------

### STE BASKET

Siebkorb  
wire basket

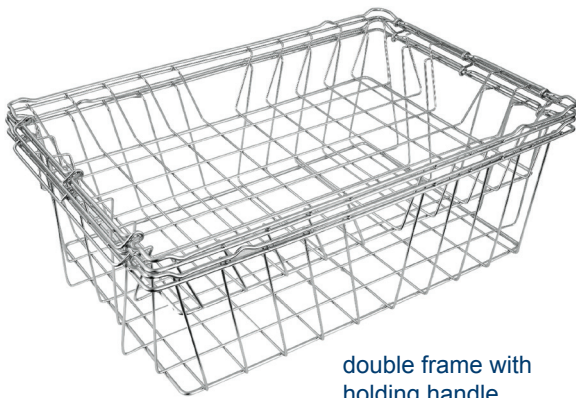

double frame with  
holding handle

<b>ST0330</b>	585 x 395 x 100 mm
---------------	--------------------

<b>ST0331</b>	585 x 395 x 195 mm
---------------	--------------------

### SPRI BASKET

Siebkorb  
wire basket

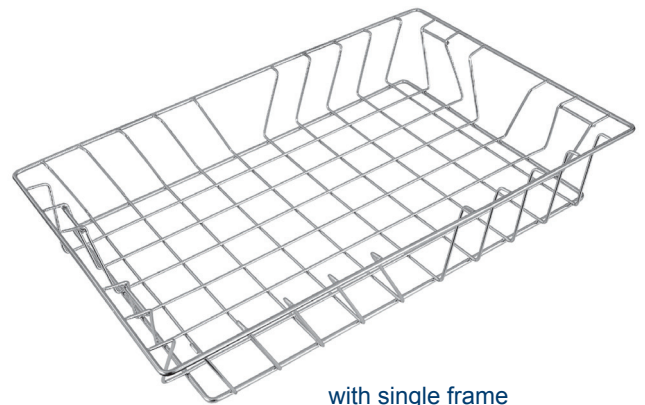

with single frame

<b>ST0354</b>	600 x 300 x 40 mm
---------------	-------------------

<b>ST0355</b>	600 x 300 x 50 mm
---------------	-------------------

<b>ST0356</b>	600 x 300 x 100 mm
---------------	--------------------

<b>ST0357</b>	600 x 300 x 130 mm
---------------	--------------------

<b>ST0358</b>	600 x 300 x 150 mm
---------------	--------------------

<b>ST0359</b>	600 x 300 x 180 mm
---------------	--------------------

<b>ST0360</b>	600 x 300 x 200 mm
---------------	--------------------

<b>ST0337</b>	600 x 400 x 100 mm
---------------	--------------------

<b>ST0338</b>	600 x 400 x 130 mm
---------------	--------------------

<b>ST0339</b>	600 x 400 x 150 mm
---------------	--------------------

<b>ST0340</b>	600 x 400 x 180 mm
---------------	--------------------

<b>ST0361</b>	600 x 400 x 200 mm
---------------	--------------------

### SPRI BASKET

Siebkorb  
wire basket



		Modell model
<b>ST5895</b>	90 x 60 cm	
<b>ST5896</b>	90 x 80 cm	für 1/2 Modell for 1/2 model
<b>ST5898</b>	130 x 45 cm	
<b>ST5899</b>	130 x 60 cm	
<b>ST5894</b>	140 x 100 cm	für 3/4 Modell for 3/4 model
<b>ST5890</b>	130 x 60 cm	
<b>ST5891</b>	140 x 100 cm	für 1/1 Modell for 1/1 model
<b>ST5892</b>	185 x 85 cm	
<b>ST5893</b>	180 x 60 cm	
<b>ST5900</b>	90 x 60 cm	für flaches Modell for flat model
<b>ST5901</b>	90 x 80 cm	
<b>ST5902</b>	60 x 40 cm	für Mini Modell for mini model
<b>ST5903</b>	60 x 40 cm	
<b>ST5904</b>	65 x 65 cm	für Dental Modell for dental model
<b>ST5905</b>	85 x 85 cm	

Einschlagtücher  
drapes

# Dentalkörbe und Trays

## dental baskets and trays



**ST0363** 274 x 180 x 34 mm

Korb mit Silikonbefestigungssystem für 17 Instrumente mit Ø 5 mm  
basket with silicone fixation systems holds 17 instruments with Ø 5 mm



**ST0362** 274 x 180 x 32 mm

Korb ohne Silikonbefestigungssystem  
basket without silicone fixation systems

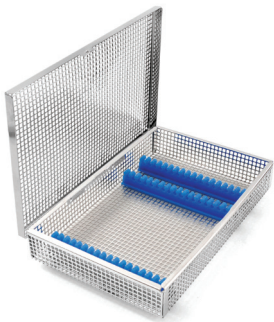

**ST0364** 274 x 180 x 44 mm

Korb mit Silikonbefestigungssystem für 17 Instrumente mit Ø 5 mm  
basket with silicone fixation systems holds 17 instruments with Ø 5 mm



**ST0365** 274 x 180 x 42 mm

**ST0366** 274 x 180 x 62 mm  
Korb ohne Silikonbefestigungssystem  
basket without silicone fixation systems

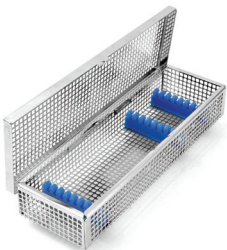

**ST0368** 274 x 88 x 46 mm

Korb mit Silikonbefestigungssystem für 8 Instrumente mit Ø 5 mm  
basket with silicone fixation systems holds 8 instruments with Ø 5 mm



**ST0367** 240 x 76 x 30 mm

Korb mit Silikonmatte  
basket with silicone mat

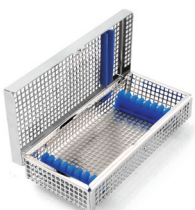

**ST0369** 188 x 86 x 36 mm

Korb mit Silikonbefestigungssystem für 8 Instrumente mit Ø 5 mm  
basket with silicone fixation systems holds 8 instruments with Ø 5 mm



**ST0370** 188 x 86 x 32 mm

Korb mit Silikonmatte  
basket with silicone mat



**ST0371** 138 x 124 x 48 mm

Korb ohne Silikonbefestigungssystem  
basket without silicone fixation systems



**ST0372** 146 x 46 x 28 mm

Korb ohne Silikonbefestigungssystem  
basket without silicone fixation systems



**ST0373** 86 x 46 x 28 mm

Korb ohne Silikonbefestigungssystem  
Wanne 2 mm, Deckel 4 mm perforiert  
basket without silicone fixation systems,  
bottom 2 mm, lid 4 mm perforation



**ST0374** 188 x 130 x 36 mm

Korb mit Silikonbefestigungssystem  
für 12 Instrumente mit Ø 5 mm  
basket with silicone fixation systems  
holds 12 instruments with Ø 5 mm



**ST0375** 188 x 130 x 34 mm

Korb ohne Silikonbefestigungssystem  
basket without silicone fixation systems

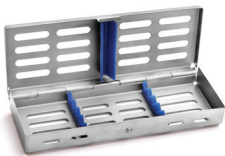

**ST0376** 186 x 72 x 24 mm

Tray mit Silikonbefestigungssystem  
für 5 Instrumente  
tray with silicone fixation systems  
holds 5 instruments



**ST0377** 186 x 99 x 24 mm

Tray mit Silikonbefestigungssystem  
für 7 Instrumente  
tray with silicone fixation systems  
holds 7 instruments



**ST0378** 186 x 137 x 24 mm

Tray mit Silikonbefestigungssystem  
für 10 Instrumente  
tray with silicone fixation systems  
holds 10 instruments

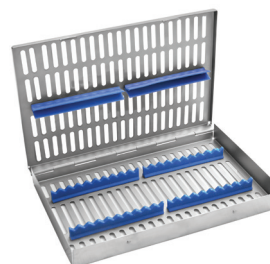

**ST0379** 286 x 192 x 34 mm

Tray mit Silikonbefestigungssystem  
für 20 Instrumente  
tray with silicone fixation systems  
holds 20 instruments



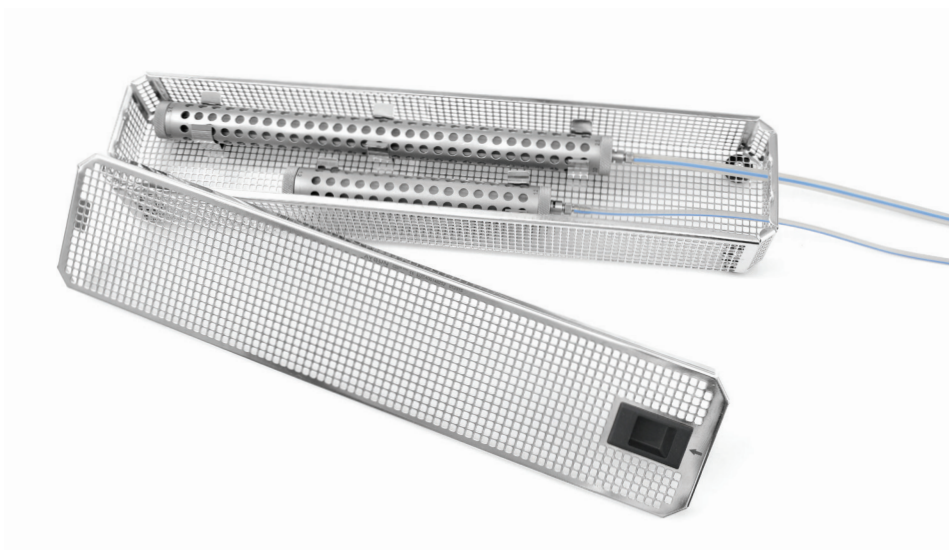

## Waschrohrsystem washer tube system

Waschrohrsystem.....82

washer tube system.....82

# Waschrohrsystem washer tube system

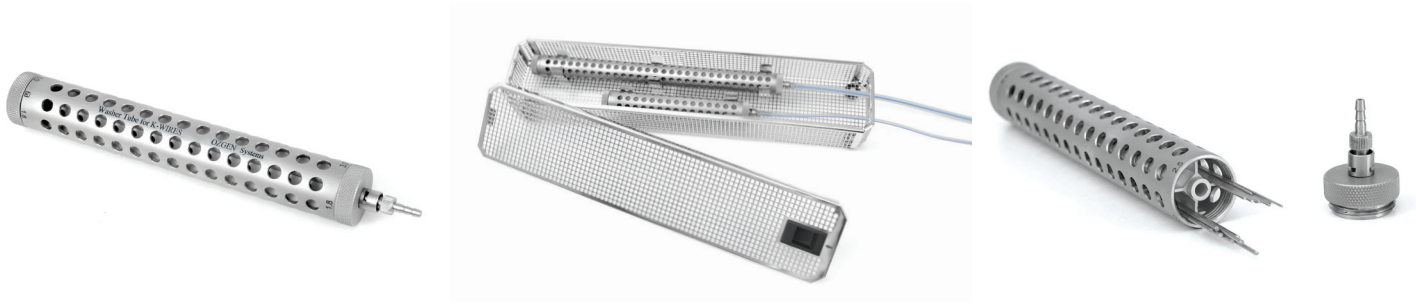

## Waschrohrsystem für Kirschner-Drähte OZGEN System

Das Waschrohrsystem wurde entwickelt, um die speziell in der orthopädischen (Trauma-) Chirurgie verwendeten K-Drähte sicher zu halten, waschen und zu sterilisieren.

Das Waschrohrsystem hat ein spezielles Design für maximale Effizienz.

Das Trennelement im Inneren des Rohrs bietet Schutz für vier Drähte unterschiedlichen Durchmessers.

Mit Hilfe des Innenrohrs, das in der Mitte der Trennwand angeordnet ist, fließt das von der Waschmaschine kommende Hochdruckwasser von innen nach außen.

Auf diese Weise werden die Drähte innerhalb der Röhre von innen nach außen und von außen nach innen gespült und der Desinfektionsprozess wird effizient abgeschlossen.

- Das System hat zwei verschiedene Längen als Option.
- Jede Röhre hat vier verschiedene Tanks für vier Drähte mit unterschiedlichen Durchmessern.
- Das System wurde für 12 verschiedene Durchmesser von 0,6 mm bis 3 mm entwickelt.

## washer tube for Kirschner-wires OZGEN Systems

The washer tube systems are designed in order to securely keep, healthfully wash and sterilize the K-Wires used especially in orthopedic (trauma) surgery.

The washer tube systems have a special design for providing maximum efficiency.

The separating element inside the tube provides protection for four wires with different diameters.

With the help of the inner tube, arranged in the middle of the separating element, the high pressure water coming from the washing machine flows from the inside to the outside.

By this means the wires within the tube are flushed from inside to outside and from outside to inside and the disinfection process is completed efficiently.

- The system has zwei different lengths as option.
- Every tube has vier different tanks for four different diameter wires.
- The system has been designed suitable for 12 different diameters from 0,6 mm to 3 mm.



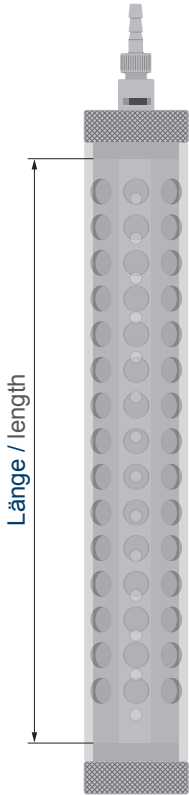

	Länge length	passender Drahtdurchmesser suitable wire diameters
<b>ST0010</b>	150 mm	Ø 0,60 mm
		Ø 0,80 mm
		Ø 1,00 mm
		Ø 1,20 mm
<b>ST0011</b>	150 mm	Ø 1,25 mm
		Ø 1,40 mm
		Ø 1,50 mm
		Ø 1,60 mm
<b>ST0012</b>	150 mm	Ø 1,80 mm
		Ø 2,00 mm
		Ø 2,50 mm
		Ø 3,00 mm
<b>ST0013</b>	300 mm	Ø 0,60 mm
		Ø 0,80 mm
		Ø 1,00 mm
		Ø 1,20 mm
<b>ST0014</b>	300 mm	Ø 1,25 mm
		Ø 1,40 mm
		Ø 1,50 mm
		Ø 1,60 mm
<b>ST0015</b>	300 mm	Ø 1,80 mm
		Ø 2,00 mm
		Ø 2,50 mm
		Ø 3,00 mm

Waschrohr  
washer tube

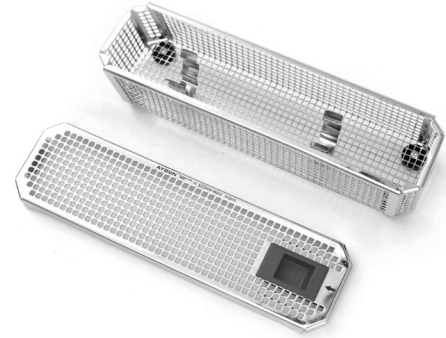

**ST0017** 265 x 72 x 64 mm

Siebkorb mit Deckel für Waschrohr  
wire basket with lid for washer tube

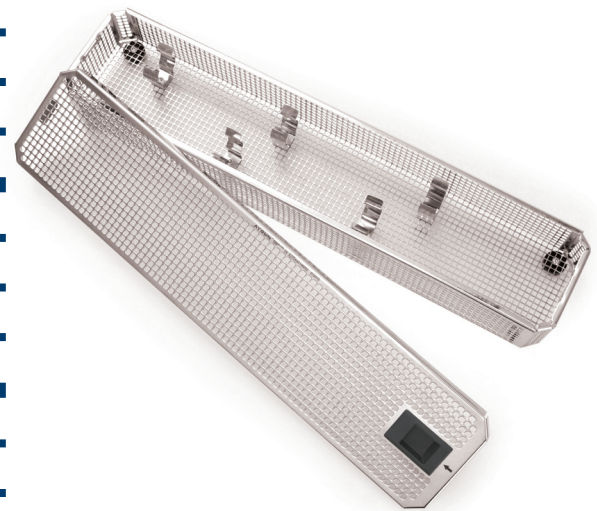

**ST0016** 460 x 100 x 64 mm

Siebkorb mit Deckel für Waschrohr  
wire basket with lid for washer tube



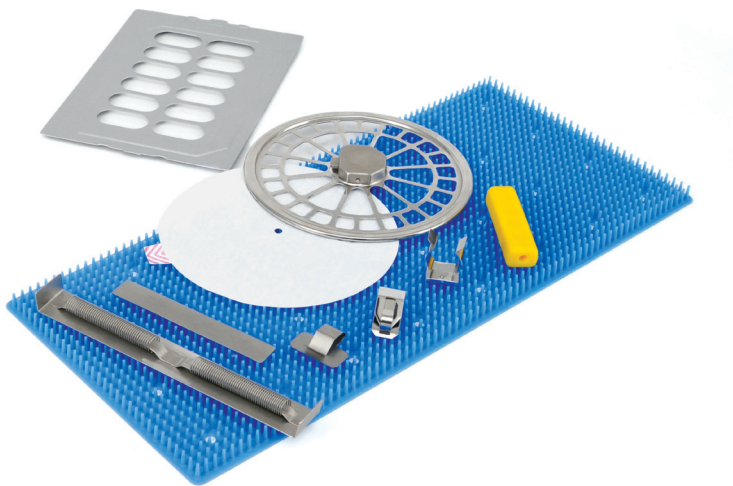

## Zubehör accessories

Beschriftungsschilder, Halter .....	86	identification labels, holder .....	86
Halter, Ständer, Spender .....	87	holder, stand, dispenser .....	87
Plomben, Sperrmechanismus .....	88	seal, Auto Lock Mechanism .....	88
Silikonbeschichtete Griffe .....	89	silicone coated handles .....	89
Filter .....	90	filters .....	90
Filterhalter, Filterspender .....	92	filter retainer, filter dispenser .....	92
Filterspender, Silikonmatten .....	93	filter dispenser, silicone mats .....	93
Trennkörbe .....	94	dividers .....	94
Trennkörbe, Drahtboden .....	95	dividers, wire base .....	95
Tuchhalter, Spannrahmen .....	96	drape retainer, drape retainer .....	96
Spannrahmen, Lagerrahmen .....	97	drape retainer, storage frame .....	97
Pin, Teiler, Fixierklemme .....	98	pin, divider, fixation clamp .....	98
Rack .....	99	rack .....	99
Teiler .....	100	divider .....	100
Kleber, Dichtungen .....	102	adhesive, gaskets .....	102
Wagen .....	103	trolleys .....	103
Instrumentenschutzkappen .....	104	instrument tip guards .....	104
Abfallzangen .....	105	swab holding forceps .....	105
Nadelsterilisierdosen .....	106	needle sterilizing cases .....	106
Sanitätsartikel .....	108	medical equipment .....	108
Instrumentenöl .....	112	instrument oil .....	112
Instrumententablett, Instrumentenrahmen .....	113	instrument tray, instrument frame .....	113

# Beschriftungsschilder, Halter identification labels, holder

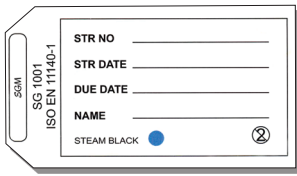

**ZB9060**

für 1/1, 3/4 und 1/2 Container,  
100 Stück/Packung  
for 1/1, 3/4 and 1/2 container,  
100 pieces/package

## LABELS

Papierschilder mit Indikator  
paper labels with indicator

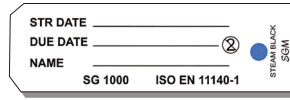

**ZB9062**

für Mini und Dental Container,  
100 Stück/Packung  
for mini and dental container,  
100 pieces/package

## LABELS

Papierschilder mit Indikator  
paper labels with indicator



## LABELS

farbige Beschriftungsschilder,  
beschriftet nach Ihren Vorgaben,  
maximal 16 Buchstaben  
coloured identification labels,  
engraved to your specifications,  
maximum 16 letters

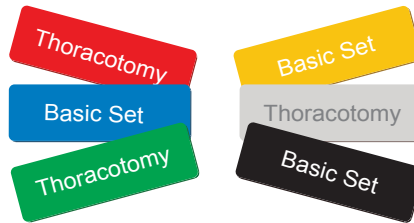

## IDENTIFICATION

Labelhalter  
label holder



## IDENTIFICATION

Label  
labels



farbige Beschriftungsetiketten, beschriftet nach Ihren Vorgaben  
coloured identification labels, engraved to your specifications



**ST5914** 40 x 35 x 9 mm

### DISPOSAL STAMP

Gewünschte Aufdruck muss bei der Bestellung angegeben werden.  
Requested number or letter must be indicated at the order.

**ZB9016** 50 x 35 x 13 mm

### LABEL HOLDER

Labelhalter  
holder for identification labels

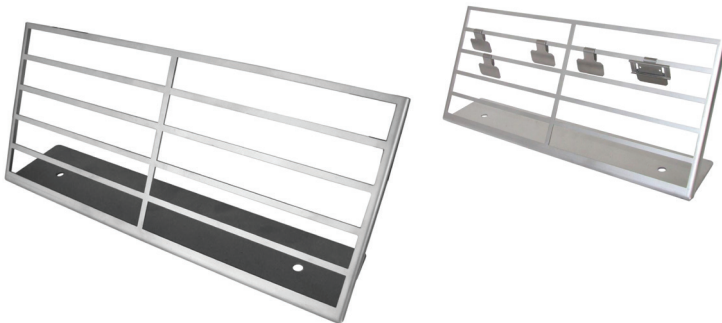

**ZB9020** 390 x 85 x 153 mm

### STORAGE STAND

Aufbewahrungsständer  
storage stand



Haltevorrichtungen nach Bedarf einstellbar.  
Schlüssel zur Verstellung der Haltevorrichtungen ist enthalten.  
Wire suspenders, adjustable as required.  
Adjustable key of suspender is included.

**ZB9085** 325 x 328 x 145 mm

### CARRIER

tragbarer Träger für kleine Container  
portable carrier for small containers

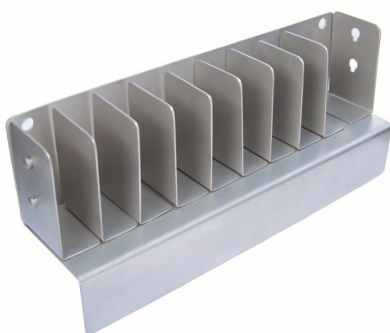

**ZB9021** 212 x 53 x 92 mm

### DISPENSER

Spender für Beschriftungsschilder  
dispenser for identification labels

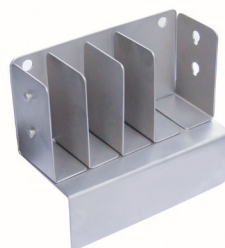

**ZB9022** 108 x 53 x 92 mm

### DISPENSER

Spender für Beschriftungsschilder  
dispenser for identification labels



**ZB1010** 100 Stück/Packung  
 100 pieces/package

### SECURITY SEAL

Schließplomben  
 security seal



**ZB1012** 100 Stück/Packung  
 100 pieces/package

### SECURITY SEAL

Schließplomben  
 security seal



**ZB9015** 2 Stück  
 2 pieces

### AUTO LOCK MECHANISM

automatischer Sperrmechanismus  
 auto lock mechanism



Was ist ein automatischer Sperrmechanismus?

Der Auto-Lock-Mechanismus ist ein wärmeempfindliches automatisches Schließsystem, das entwickelt wurde, um die Sterilisationskontrolle zu erleichtern.

Es ist ein modulares automatisches Schließsystem, das für die Verwendung unterschiedlicher Behältersystemen entwickelt wurde, die zu verschiedenen Marken gehören.

Dieses System wurde in Übereinstimmung mit den Anforderungen der Sterilisation für den Einsatz in einem Dampfautoklaven für unsere Behältersysteme entwickelt. Auto Lock wird aus wiederverwendbarem Material hergestellt.

Die minimale Lebensdauer des Systems beträgt 5.000 Sterilisationszyklen. Während dieser Zeit ist das System ohne Wartung oder Service nutzbar.

What is auto lock mechanism?

Auto lock mechanism is a heat-sensitive automatic locking system developed in order to ease sterilization control.

Modular auto lock system designed to be usable with different container systems which are belongs to different brands.

This system has been developed in accordance with the requirements of sterilization to be used in a steam autoclave for our container systems. Auto lock is made of reusable material.

The minimum lifetime of the system is 5,000 sterilization cycles. During this time the system can be used without maintenance or service.



■ CT9010R

■ CT9010B

■ CT9010S

■ CT9010Y

■ CT9010G

■ CT9010A

### SILICONE HOSE

silikonbeschichteter Griff  
silicone coated handle



**CT9010**

Griff allein  
handle only

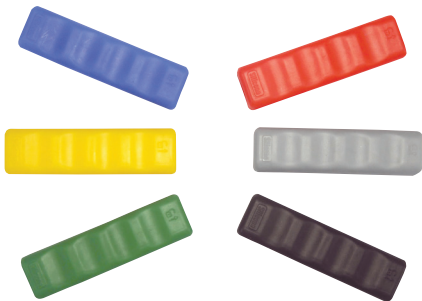

■ ZB9010R

■ ZB9010B

■ ZB9010S

■ ZB9010Y

■ ZB9010G

■ ZB9010A

### SILICONE HANDLE

Silikongriff,  
vom Benutzer abnehmbar  
silicone handle, detachable by user



# Filter filters

für 1/1, 3/4, 1/2, MAGNUM, extra lang und extra breiter Dental Container  
for 1/1, 3/4, 1/2, MAGNUM, extra long and extra large dental container

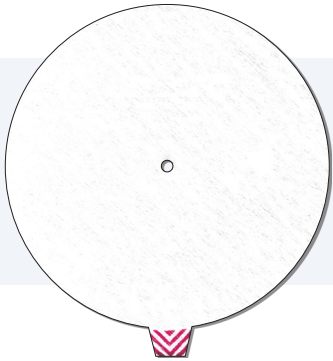
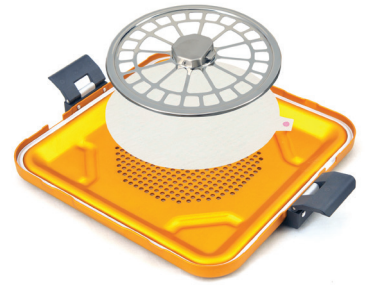

**ZB9095**

Ø 184 mm

## FILTER

Papierfilter mit Indikator,  
zum Einmalgebrauch, 100 Stück/Packung  
paper filters with indicator,  
for single use, 100 pieces/package



**ZB9094**

Ø 194 mm

## TEFLON FILTER

Teflonfilter  
teflon filters

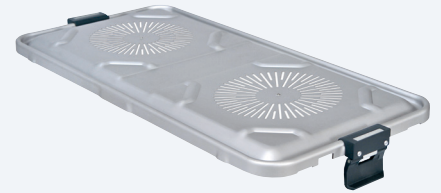

für Dental Modell  
for dental model

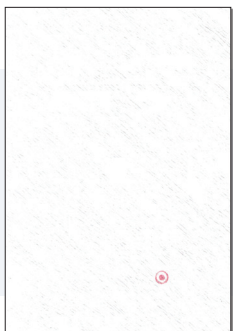

**ZB9066**

165 x 235 mm

## FILTER

Papierfilter mit Indikator,  
zum Einmalgebrauch, 100 Stück/Packung  
paper filters with indicator,  
for single use, 100 pieces/package

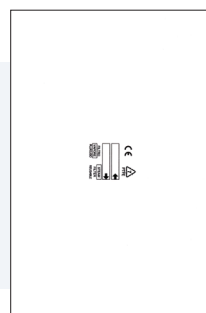

**ZB9100**

150 x 217 mm

## TEFLON FILTER

Teflonfilter  
teflon filters

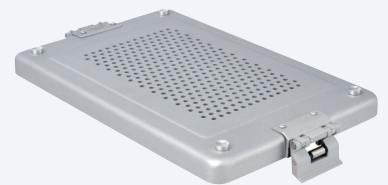



für Mini Modell und Endocontainer  
for mini model and endo container

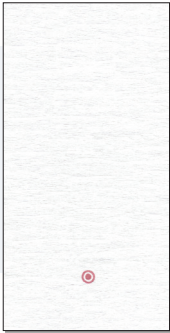

**ZB9098** 235 x 120 mm

### FILTER

Papierfilter mit Indikator,  
zum Einmalgebrauch, 100 Stück/Packung  
paper filters with indicator,  
for single use, 100 pieces/package

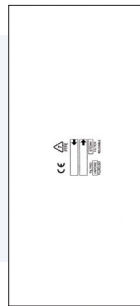

**ZB9099** 215 x 100 mm

### TEFLON FILTER

Teflonfilter  
teflon filters

für 1/2 Dental Modell  
for 1/2 dental model

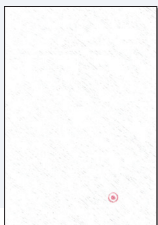

**ZB9096** 130 x 110 mm

### FILTER

Papierfilter mit Indikator,  
zum Einmalgebrauch, 100 Stück/Packung  
paper filters with indicator,  
for single use, 100 pieces/package



**ZB9097** 130 x 110 mm

### TEFLON FILTER

Teflonfilter  
teflon filters



**ZB9091** Ø 186 mm

### FILTER RETAINER

für Papierfilter  
für 1/2, 3/4, 1/1, MAGNUM, extra lang und  
extra breiter Dental Container  
for paper filters  
for 1/2, 3/4, 1/1, MAGNUM, extra long and  
extra large dental container

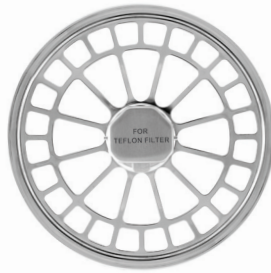

**ZB9092** Ø 186 mm

### FILTER RETAINER

für PTFE Teflonfilter  
für 1/2, 3/4, 1/1, MAGNUM, extra lang und  
extra breiter Dental Container  
for PTFE teflon filters  
for 1/2, 3/4, 1/1, MAGNUM, extra long and  
extra large dental container



**ZB9106** Ø 189 mm

### ALUMINIUM FILTER RETAINER

für 1/2, 3/4, 1/1 Basic Plus Container  
for 1/2, 3/4, 1/1 basic plus container

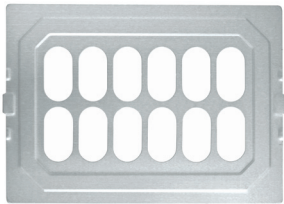

**ZB9103** 247 x 172 mm

### FILTER RETAINER

für Dental Modell  
für Papier- und Teflonfilter, Seite 90 und 91  
for dental model  
for paper and teflon filters, page 90 and 91

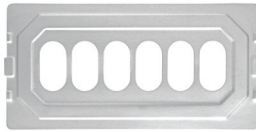

**ZB9104** 243 x 120 mm

### FILTER RETAINER

für Mini Modell  
für Papier- und Teflonfilter, Seite 90 und 91  
for mini model  
for paper and teflon filters, page 90 and 91



**ZB9105** 162 x 144 mm

### FILTER RETAINER

für 1/2 Dental Modell  
für Papier- und Teflonfilter, Seite 90 und 91  
for 1/2 dental model  
for paper and teflon filters, page 90 and 91

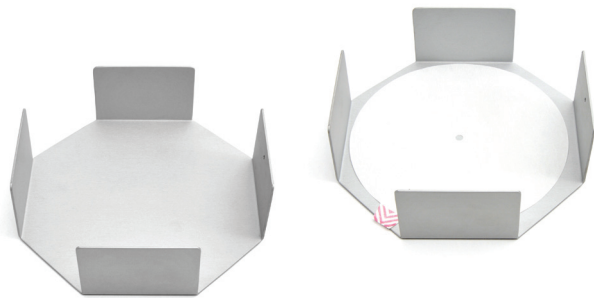

**ZB9090** 200 x 200 x 64 mm

### FILTER DISPENSER

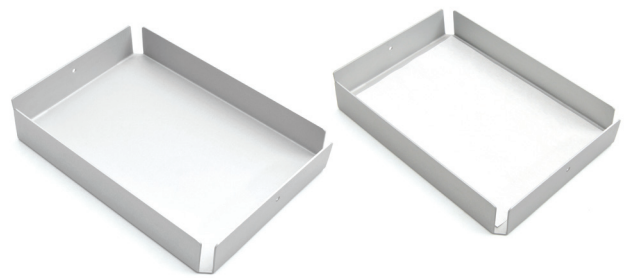

**ZB9080** 250 x 177 x 40 mm

### FILTER DISPENSER

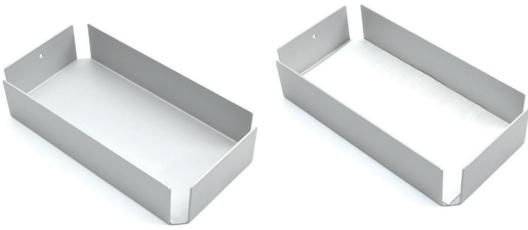

**ZB9081** 250 x 127 x 53 mm

**FILTER DISPENSER**

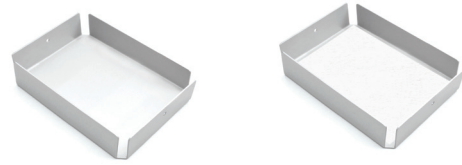

**ZB9082** 169 x 151 x 53 mm

**FILTER DISPENSER**

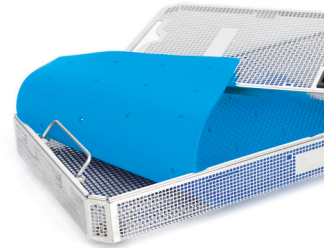
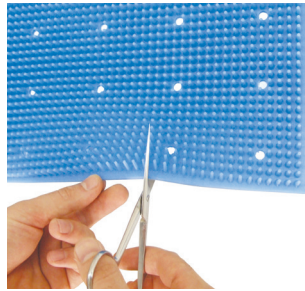
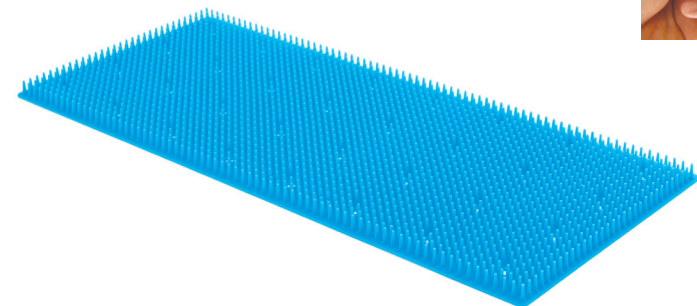
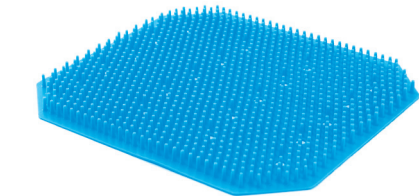
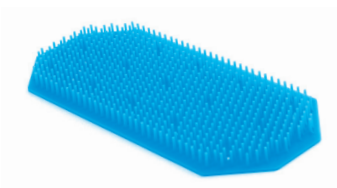

<b>ST5261</b>	150 x 130 mm
<b>ST5399</b>	275 x 125 mm
<b>ST5596</b>	250 x 235 mm
<b>ST5883</b>	340 x 230 mm (2 pcs)
<b>ST5597</b>	380 x 230 mm
<b>ST5598</b>	440 x 230 mm
<b>ST5599</b>	520 x 230 mm
<b>ST5599-1</b>	470 x 230 mm
<b>ST5256</b>	260 x 180 mm
<b>ST5374</b>	280 x 200 mm

Silikonmatten  
silicone mats

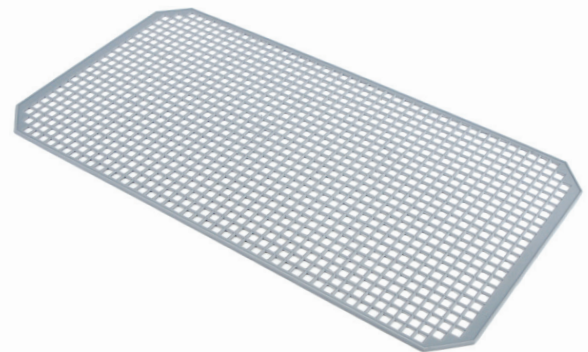

**ST5595** 250 x 240 mm

**ST5593** 480 x 250 mm

Silikongittermatten  
silicone mesh mats

# Trennkörbe dividers



<b>ST5542</b>	255 x 245 x 130 mm
---------------	--------------------

<b>ST5543</b>	255 x 245 x 180 mm
---------------	--------------------

Trennkorb 1/2  
dividers 1/2



<b>ST5643</b>	405 x 250 x 80 mm
---------------	-------------------

<b>ST5644</b>	405 x 250 x 110 mm
---------------	--------------------

<b>ST5645</b>	405 x 250 x 130 mm
---------------	--------------------

Trennkorb 3/4  
dividers 3/4



<b>ST5747</b>	540 x 250 x 130 mm
---------------	--------------------

<b>ST5748</b>	540 x 250 x 180 mm
---------------	--------------------

Trennkorb 1/1  
dividers 1/1



<b>ST5875</b>	533 x 337 x 70 mm
---------------	-------------------

<b>ST5875-1</b>	533 x 337 x 120 mm
-----------------	--------------------

Trennkorb MAGNUM  
dividers MAGNUM



<b>ST5640</b>	405 x 250 x 80 mm
---------------	-------------------

<b>ST5641</b>	405 x 250 x 110 mm
---------------	--------------------

<b>ST5642</b>	405 x 250 x 130 mm
---------------	--------------------

Trennkorb 3/4  
dividers 3/4



<b>ST5742</b>	540 x 250 x 130 mm
---------------	--------------------

<b>ST5743</b>	540 x 250 x 180 mm
---------------	--------------------

Trennkorb 1/1 und extra lang  
dividers 1/1 and extra long



<b>ST5876</b>	533 x 337 x 70 mm
---------------	-------------------

<b>ST5877</b>	533 x 337 x 120 mm
---------------	--------------------

Trennkorb MAGNUM  
dividers MAGNUM



<b>ST5590</b>	255 x 255 x 30 mm
---------------	-------------------

Drahtboden 1/2  
wire base 1/2



<b>ST5690</b>	405 x 255 mm
---------------	--------------

Drahtboden 3/4  
wire base 3/4



<b>ST5790</b>	545 x 255 x 30 mm
---------------	-------------------

Drahtboden 1/1 und extra lang  
wire base 1/1 and extra long



<b>ST5386</b>	270 x 125 mm
---------------	--------------

Drahtboden für Dental Mini Modell  
wire base for dental mini model

# Tuchhalter, Spannrahmen drape retainer, drape retainer

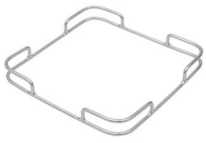

**ST5592** 255 x 255 x 30 mm

Tuchhalter 1/2  
drape retainer 1/2

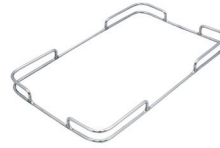

**ST5693** 405 x 255 x 30 mm

Tuchhalter 3/4  
drape retainer 3/4

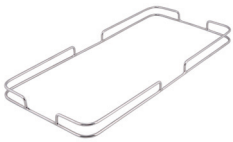

**ST5792** 545 x 255 x 30 mm

Tuchhalter 1/1  
drape retainer 1/1

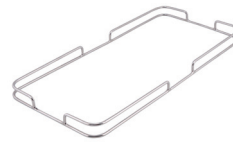

**ST5878** 533 x 337 x 30 mm

Tuchhalter MAGNUM  
drape retainer MAGNUM



**ST5591** 255 x 255 mm

Spannrahmen 1/2  
drape retainer 1/2



**ST5691** 405 x 255 mm

Spannrahmen 3/4  
drape retainer 3/4



**ST5791** 545 x 255 mm

Spannrahmen 1/1  
 drape retainer 1/1



**ST5879** 533 x 337 mm

Spannrahmen MAGNUM  
 drape retainer MAGNUM

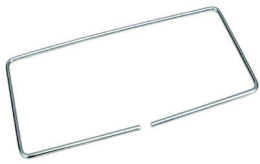

**ST5255** 277 x 175 mm

Tuchhalter für Dentalmodell 1/1  
 drape retainer for dental model 1/1



**ST5260** 170 x 140 mm

Tuchhalter für Dentalmodell 1/2  
 drape retainer for dental model 1/2



**ST5391** 270 x 125 mm

Tuchhalter für Dental Mini Modell  
 drape retainer for dental mini model

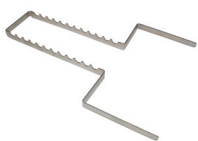

**ST5259** 170 x 140 mm

Lagerrahmen für Dentalmodell 1/2  
 storage frame for dental model 1/2

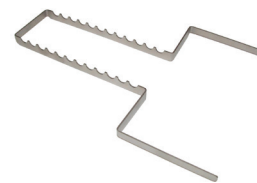

**ST5254** 273 x 180 x 13 mm

Lagerrahmen für Dentalmodell 1/1  
 storage frame for dental model 1/1

# Pin, Teiler, Fixierklemme pin, divider, fixation clamp

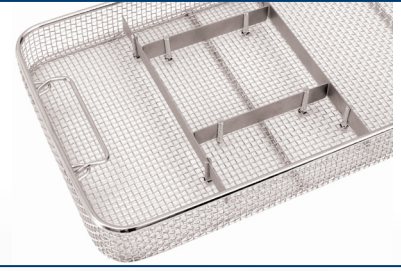
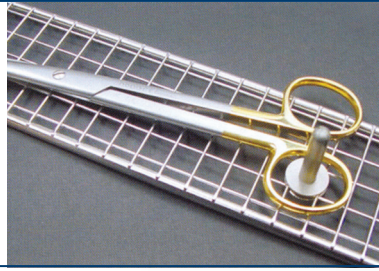
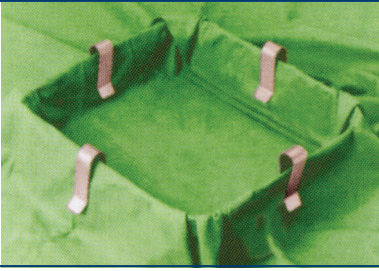

**ST5969**

Haltestift für Teiler  
holding pin for divider



**ST5970**

Haltestift für Instrumente  
holding pin for instruments

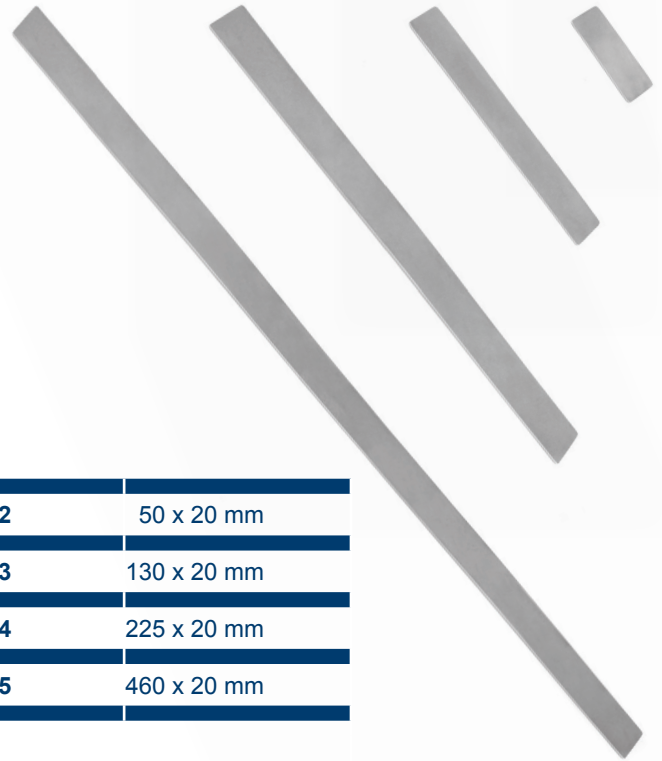

<b>ST5972</b>	50 x 20 mm
<b>ST5973</b>	130 x 20 mm
<b>ST5974</b>	225 x 20 mm
<b>ST5975</b>	460 x 20 mm

Teiler  
divider



**ST5913**

Fixierklemme  
fixation clamp



**ST5985**

Ø 7 - 12 mm

Fixierklemme  
fixation clamp



**ST5986**

Ø 12 - 16 mm

Fixierklemme  
fixation clamp



**ST5987**

Ø 16 - 26 mm

Fixierklemme  
fixation clamp



**ST5988**

Ø 26 - 36 mm

Fixierklemme  
fixation clamp



**ST5989**

Ø 36 - 45 mm

Fixierklemme  
fixation clamp





**ZB9025**

98 x 43 x 44 mm

Rack für 24 Bohrer mit  $\varnothing$  2,35 mm  
rack for 24 burs with shanks  $\varnothing$  2,35 mm



**ZB9026**

163 x 103 x 40 mm

Rack für 24 Instrumente  
rack for 24 pcs of instruments



**ZB9027**

218 x 22 x 54 mm

Rack für 12 Instrumente  
rack for 12 pcs of instruments

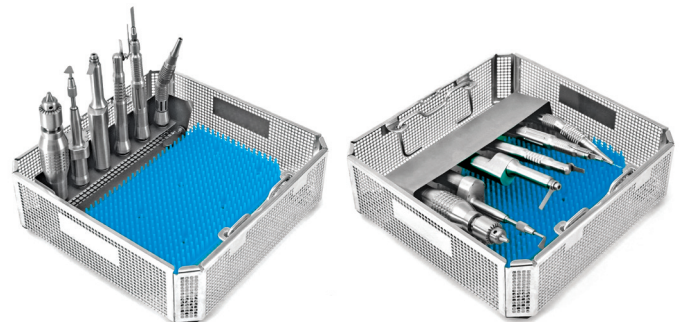

**ZB9028**

218 x 45 x 52 mm

schwenkbare Haltevorrichtung für 6 Mikroköpfe  
tiltable holding device for 6 micro heads

# Teiler divider



<b>ST5930</b>	40 x 5 x 18 mm
---------------	----------------

Teiler (benutzen mit ST59321 und ST5932)  
divider (use with ST5931 and ST5932)



<b>ST5931</b>	230 x 26 mm
---------------	-------------

<b>ST5932</b>	470 x 26 mm
---------------	-------------

Gleitschienen mit Sicherheitsschrauben  
sliding rails with security screws



<b>ST5933</b>	230 x 26 mm
---------------	-------------

<b>ST5934</b>	470 x 26 mm
---------------	-------------

begrenzende Stange, mit Sicherheitsschrauben  
limiting bar, with security screws

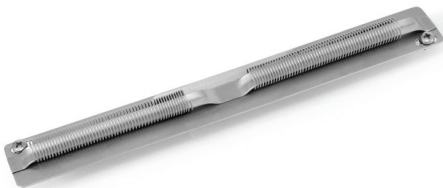

<b>ST5935</b>	233 x 30 mm
---------------	-------------

Spiralhaltevorrichtung  
spiral holding device

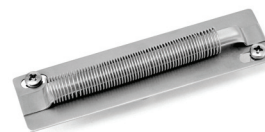

<b>ST5915</b>	116 x 30 mm
---------------	-------------

Spiralhaltevorrichtung  
spiral holding device

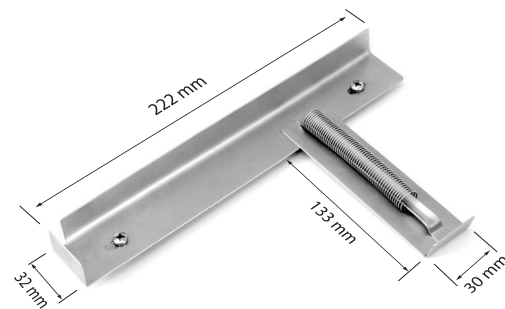
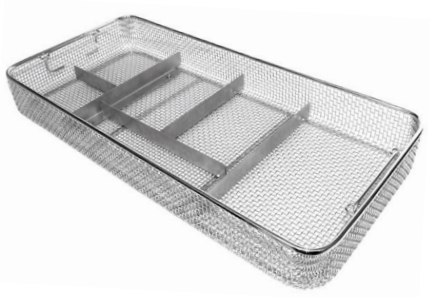

<b>ST5916</b>	112 x 18 mm
<b>ST5917</b>	172 x 18 mm
<b>ST5918</b>	232 x 18 mm
<b>ST5919</b>	472 x 18 mm

begrenzende Stange  
limiting bar

**ST5921**  
Spiralhalter  
spiral holding



<b>ST5922</b>	223 x 30 mm
---------------	-------------

Spiralhalter  
spiral holding

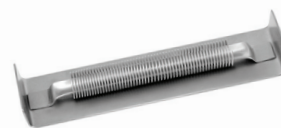

<b>ST5923</b>	126 x 30 mm
---------------	-------------

Spiralhalter  
spiral holding



<b>ZB9000</b>	310 ml ± 5%
---------------	-------------

Silikonkleber für ZB9001 - ZB9009  
silicone adhesive for ZB9001 - ZB9009



	Modell model	Grösse size
<b>ZB9002-1</b>	large dental silicone gasket	1180 mm
<b>ZB9004-1</b>	1/2 dental silicone gasket	720 mm
<b>ZB9001</b>	mini silicone gasket	770 mm
<b>ZB9002</b>	dental silicone gasket	890 mm
<b>ZB9003</b>	flat silicone gasket	1010 mm
<b>ZB9004</b>	1/2 silicone gasket	1010 mm
<b>ZB9005</b>	3/4 silicone gasket	1360 mm
<b>ZB9006</b>	1/1 silicone gasket	1580 mm
<b>ZB9007</b>	extra large silicone gasket	1800 mm
<b>ZB9008</b>	extra long silicone gasket	1850 mm
<b>ZB9009</b>	endo silicone gasket	1300 mm

Silikondichtungen für Deckel  
silicone gaskets for lids

Zur Montage wird Silikonkleber ZB9000 verwendet.  
For mounting, ZB9000 silicone adhesive is used.



**ZB9200**

Wagen  
trolley

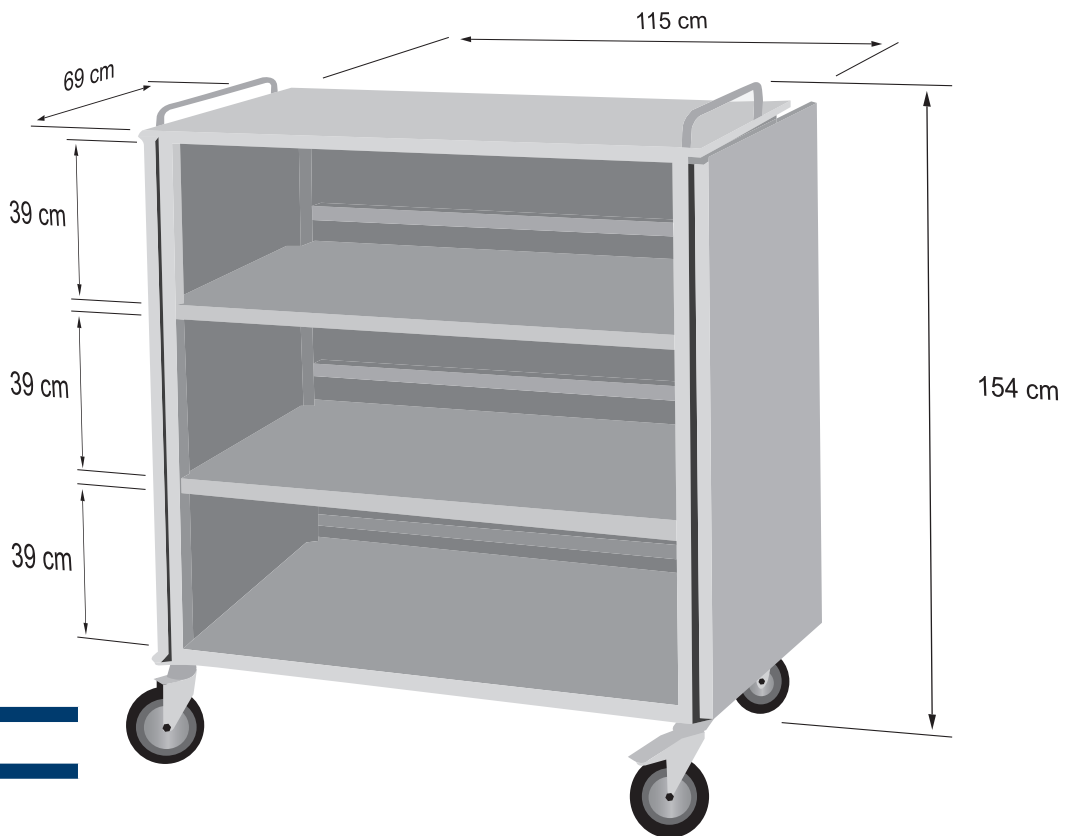

**ZB9201**

Wagen  
trolley

# Instrumentenschutzkappen instrument tip guards

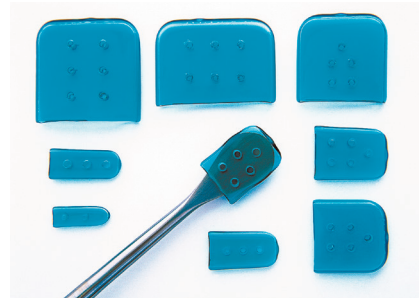

	Farbe colour	Maße dimension
<b>DSP023</b>	violett purple	51 mm
<b>DSP024</b>	rot red	51 mm

Instrumentenschutzkappen transluzent  
1 Packung = 70 Stück  
instrument tip guards translucent  
1 package = 70 pieces

	Größe size	Maße dimension
<b>DSP101</b>	1	5 x 15 mm
<b>DSP102</b>	2	10 x 25 mm
<b>DSP103</b>	3	13 x 25 mm
<b>DSP104</b>	4	19 x 25 mm
<b>DSP105</b>	5	25 x 25 mm
<b>DSP106</b>	6	32 x 32 mm
<b>DSP107</b>	7	38 x 38 mm
<b>DSP108</b>	8	45 x 38 mm

Osteotome Schutzkappen perforiert,  
1 Packung = 50 Stück  
osteotome guards perforated,  
1 package = 50 pieces

	Größe size	Farbe colour	Maße dimension
<b>DSP121</b>	1	weiss white	1,6 x 19 mm
<b>DSP122</b>	2	blau blue	2,0 x 19 mm
<b>DSP123</b>	3	grün green	2,8 x 19 mm
<b>DSP124</b>	4	rot red	3,2 x 25,4 mm
<b>DSP125</b>	5	gelb yellow	4,8 x 25,4 mm
<b>DSP126</b>	6	violett violet	10,3 x 19 mm
<b>DSP127</b>	7	orange orange	1,6 x 9,5 x 25,4 mm
<b>DSP128</b>	8	braun brown	1,6 x 15,9 x 25,4 mm
<b>DSP129</b>	9	schwarz black	3,2 x 25,4 x 25,4 mm
<b>DSP130</b>			gemischte Packung variety pack

Instrumentenschutzkappen perforiert, transluzent  
1 Packung = 100 Stück  
dienen zum Transportschutz scharfer Instrumente, nicht zur  
Sterilisation  
instrument guards perforated, translucent  
1 package = 100 pieces  
serve to protect the transport of sharp instruments, not to  
sterilization



1/3

**ST0101** 200 mm, 8", Ø 5 mm

Abfallzange  
swab holding forceps



1/3

**ST0103** 550 mm, 21½"

**SAUERBRUCH**  
Abfallzange  
swab holding forceps



1/3

**ST0104** 580 mm, 22¾"

**MARTIN**  
Abfallzange  
swab holding forceps

# Nadelsterilisierdosen needle sterilizing cases



Innendose allein  
inner case only

	Ø diameter	Höhe height
<b>ND0850</b>	65 mm	17 mm
	komplett mit gelochter Innendose und ungelochter Außendose complete with perforated inner case and unperforated outer case	
<b>ND0852</b>	gelochte Innendose ohne Außendose perforated inner case without outer case	
<b>ND0851</b>	ungelochte Außendose unperforated outer case	

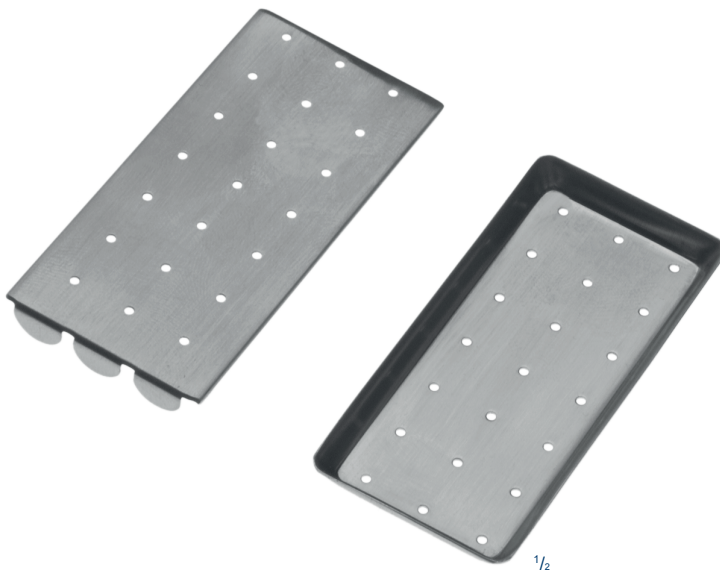

	Maße dimension
<b>ND0820</b>	50 x 25 x 4,5 mm
<b>ND0830</b>	65 x 42 x 8,0 mm
<b>ND0840</b>	75 x 25 x 4,5 mm

Nadeletui gelocht  
needle box perforated



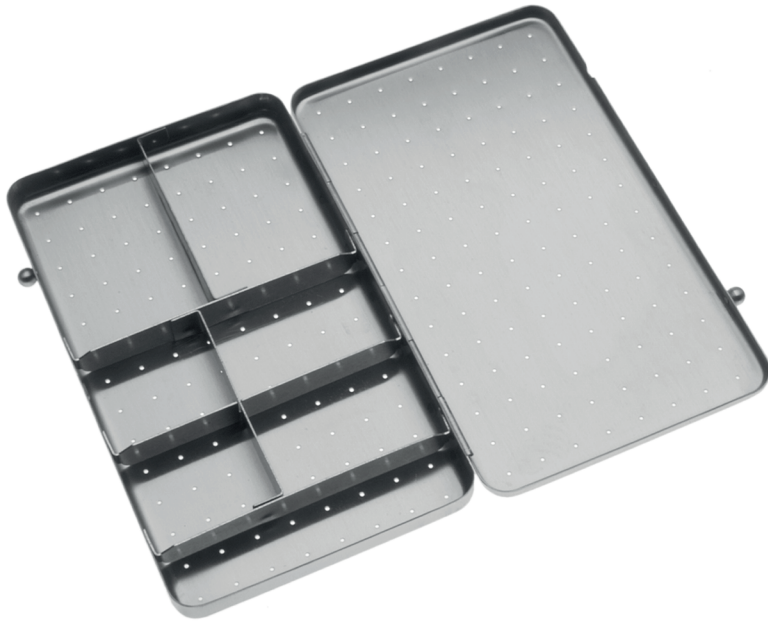

	Maße dimension
<b>ND0880</b>	150 x 95 x 13 mm

Nadeldose mit 7 Fächern, gelocht  
needle cases with 7 compartmaents, perforated



	Maße dimension
<b>ND0890</b>	205 x 120 x 15 mm

Nadeldose mit 12 Fächern, gelocht  
needle cases with 12 compartmaents, perforated

## Sanitätsartikel medical equipment



	Volumen capacity	Ø diameter	Höhe height
<b>SL0090</b>	0,05 l	53 mm	45 mm

Medizinbecher graduiert  
medicine cup graduated



	Volumen capacity	Ø diameter	Höhe height
<b>SL0093</b>	0,03 l	50 mm	25 mm

Medizinbecher graduiert  
medicine cup graduated



	Volumen capacity	Ø diameter	Höhe height
<b>SL0094</b>	0,05 l	53 mm	45 mm

Medizinbecher graduiert  
medicine cup graduated



	Volumen capacity	Ø diameter	Höhe height
<b>SL1002</b>	B1 0,02 l	40 mm	19 mm
<b>SL1004</b>	B2 0,06 l	60 mm	30 mm
<b>SL1006</b>	B4 0,16 l	85 mm	40 mm
<b>SL1008</b>	B6 0,4 l	110 mm	55 mm
<b>SL1010</b>	B8 1,0 l	150 mm	75 mm

Laborschale (Typ B), schwere Ausführung  
laboratory bowl (typ B), heavy weight model



	Volumen capacity	Ø diameter	Höhe height
<b>SL0980</b>	0,05 l	50 mm	45 mm
<b>SL0981</b>	0,075 l	60 mm	52 mm

Medizinbecher graduiert  
medicine cup graduated



	Volumen capacity	Ø diameter	Höhe height
<b>SL0990</b>	0,1 l	80 mm	35 mm
<b>SL0991</b>	0,2 l	90 mm	55 mm
<b>SL0992</b>	0,3 l	100 mm	65 mm
<b>SL0993</b>	0,4 l	120 mm	70 mm

Lösungsschale  
solution bowl

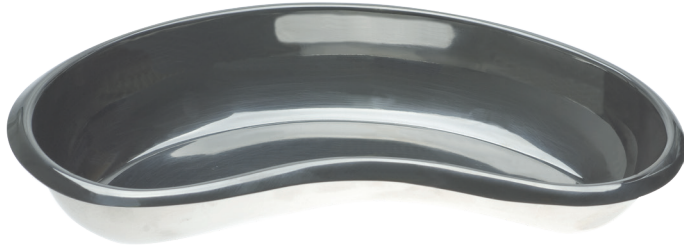

	Länge length	Höhe height	Inhalt capacity
<b>SL0117</b>	180 mm	37 mm	0,25 l
<b>SL0123</b>	205 mm	42 mm	0,35 l
<b>SL0125</b>	250 mm	39 mm	0,50 l
<b>SL0275</b>	275 mm	45 mm	0,75 l

	Ø diameter	Höhe height
<b>SL0080</b>	100 mm	20 mm

Petrischale mit Deckel  
petri dish with lid

Nierenschale  
kidney dish



	Ø diameter	Höhe height
<b>ST0090</b>	30 mm	95 mm
<b>ST0091</b>	50 mm	105 mm
<b>ST0092</b>	50 mm	135 mm
<b>ST0093</b>	50 mm	180 mm
<b>ST0094</b>	82 mm	135 mm
<b>ST0095</b>	85 mm	175 mm
<b>ST0096</b>	95 mm	200 mm

Standzylinder  
(Thermometer- und Zangenbehälter)  
thermometer and forceps holder



	Ø diameter	Höhe height	Inhalt capacity
<b>SL0130</b>	60 mm	60 mm	0,15 l
<b>SL0131</b>	85 mm	85 mm	0,4 l
<b>SL0132</b>	85 mm	50 mm	0,25 l
<b>SL0133</b>	100 mm	100 mm	0,75 l
<b>SL0134</b>	100 mm	60 mm	0,35 l
<b>SL0135</b>	120 mm	120 mm	1,25 l
<b>SL0136</b>	150 mm	150 mm	2,5 l
<b>SL0137</b>	150 mm	100 mm	1,75l
<b>SL0138</b>	200 mm	200 mm	6,0 l
<b>SL0139</b>	200 mm	100 mm	3,0 l

Watte- und Tupferbehälter  
gallipot

	Ø diameter	
<b>SL0140</b>	60 mm	zu, for SL0130
<b>SL0141</b>	85 mm	zu, for SL0131, SL0132
<b>SL0143</b>	100 mm	zu, for SL0133, SL0134
<b>SL0145</b>	120 mm	zu, for SL0135
<b>SL0146</b>	150 mm	zu, for SL0136, SL0137
<b>SL0148</b>	200 mm	zu, for SL0138, SL0139

Deckel  
lid



	Länge length	Breite width	Höhe height
<b>SL1020</b>	200 mm	150 mm	40 mm
<b>SL1021</b>	250 mm	200 mm	40 mm
<b>SL1022</b>	300 mm	205 mm	55 mm
<b>SL1023</b>	350 mm	250 mm	60 mm
<b>SL1024</b>	400 mm	300 mm	70 mm
<b>SL1025</b>	450 mm	300 mm	80 mm
<b>SL1026</b>	450 mm	300 mm	80 mm

Verbandstoffschale  
dressing tray



	Ø diameter	Inhalt capacity	Höhe height
<b>SL1119</b>	285 mm	6,0 l	145 mm

Schale für Maquet-Ständer  
bowl for maquet holder

	Ø diameter	Inhalt capacity	Höhe height
<b>SL1105</b>	135 mm	0,5 l	65 mm
<b>SL1107</b>	145 mm	0,75 l	80 mm
<b>SL1110</b>	160 mm	1,0 l	75 mm
<b>SL1120</b>	220 mm	2,0 l	75 mm
<b>SL1130</b>	240 mm	3,0 l	95 mm
<b>SL1145</b>	260 mm	4,5 l	120 mm
<b>SL1160</b>	300 mm	6,0 l	115 mm
<b>SL1180</b>	320 mm	8,0 l	140 mm
<b>SL1111</b>	380 mm	11,0 l	130 mm
<b>SL1114</b>	400 mm	14,0 l	155 mm

Universal- und Laborschale  
laborator bowl



	Höhe height	Volumen capacity
<b>SL0095</b>	50 mm	0,10 l
<b>SL0096</b>	70 mm	0,25 l

Meßbecher graduiert (5-10-15-20-25 cl)  
measure graduated



	Skalierung graduation	Höhe height	Volumen capacity
<b>SL0099</b>	á 100 ml	110 mm	0,5 l
<b>SL0100</b>	á 0,5 l	140 mm	1,0 l
<b>SL0101</b>	á 0,5 l	160 mm	1,5 l
<b>SL0102</b>	á 0,5 l	200 mm	2,0 l

Meßbecher graduiert  
measure graduated

# Instrumentenöl instrument oil



**OL5000**

Instrumentenöl  
instrument oil



	Maße dimension
<b>SL0050</b>	215 x 150 x 18 mm
<b>SL0051</b>	295 x 200 x 18 mm
<b>SL0052</b>	360 x 240 x 10 mm
<b>SL0053</b>	400 x 270 x 10 mm
<b>SL0054</b>	490 x 320 x 10 mm
<b>SL0055</b>	450 x 330 x 10 mm

Instrumententablett  
instrument tray



**ST0007**

Instrumentenrahmen mit Hängekabinett  
instrument frame with holders







## Hardware und Zubehör für Software hardware and accessories for software

ARIS Smart Tracking Lösung .....	116
BarCon Software System .....	118
ASANUS PRINTMAX .....	119
ASANUS PRINTSTAR mit Abschneidevorrichtung .....	121
ASANUS PRINTSTAR.....	122
ASANUS PROF1106 mit Abschneidevorrichtung.....	125
ASANUS PROF1106.....	126
Scanner .....	128
Stativleuchten und Webcam.....	129

ARIS smart tracking solution .....	116
BarCon software system .....	118
ASANUS PRINTMAX .....	119
ASANUS PRINTSTAR with label rewinder.....	121
ASANUS PRINTSTAR.....	122
ASANUS PROF1106 with label rewinder .....	125
ASANUS PROF1106.....	126
scanner .....	128
tripod lamp and webcam .....	129

# ARIS Smart Tracking

RFID Lösung für Container- und Sieberfassung  
RFID solution for container and set registration



- schnell und sicher packen
- immer alle Instrumente im Sieb
- immer die richtigen Instrumente
- automatische Registrierung
- fast and safe packing
- always all instruments in the tray
- always the right instruments
- automatic registration



	ARIS RFID	Größe size	EU-Version	inkl. ASANUS Registrierungslizenz incl. ASANUS registration license
<b>ARIS0200EU</b>	Benutzer-Etikett selbstklebend user stick-on label	43 x 18 mm	x	x
<b>ARIS0300EU</b>	Chip rechteckig chip square	6,0 x 2,0 x 2,0 mm	x	x
<b>ARIS0750EU</b>	Chip Endoskopie chip endoscopy	20 x 23 mm	x	x
<b>ARIS0905EU</b>	Chip Container rechteckig chip container square	51 x 36,3 x 7,5 mm	x	x

## ARIS RFID

Etikett, Chip

## ARIS RFID

label, chip

### ARIS4200

## ARIS KLEBESET

bestehend aus: 2 x ARIS Cover Glue und  
1 x ARIS Power Glue für 500 Klebungen

## ARIS GLUING SET

existing of: 2 x ARIS Cover Glue and  
1 x ARIS Power Glue for 500 bondings

### ARIS4300

## ARIS KLEBER

Anhaftkleber für Endoskope

## ARIS GLUE

glue for endoscopy



### Etikettendrucker für das BarCon Software System

Das ASANUS BarCon Software System bietet Ihnen eine hochwertige Instrumenten- und Managementsoftware, mit welcher Sie Vorgänge in der AEMP und im OP professionell und sicher dokumentieren können.

Die Software gliedert sich in zwei Hauptbereiche, welche erstens das Sterilgutmanagement einschließlich der Implantate, und zweitens das ganzheitliche Bestellwesen und die Leistungserfassung je Fall, Kostenstelle und Materialart umfassen.

Um dieses System zu unterstützen sowie Hardware-Probleme zu vermeiden, bitten wir Sie, ausschließlich die in diesem Katalog aufgeführten Produkte zu verwenden, da diese auf unser System abgestimmt sind.

### attraktives Design und kompakte Baugröße

- kostengünstiger Einstiegsdrucker für kleinere Druckaufkommen
- Thermodirekt- oder Thermotransferdruck
- Druckgeschwindigkeit bis zu 200 mm/s
- Druckbreite bis 106,6 mm - serieller, paralleler, USB- und Netzwerkanschluss

Die PRINTMAX Serie druckt wahlweise im Thermodirekt- oder Thermotransferverfahren. Das ansprechende Design fügt sich in verschiedene Umgebungen ein. Etikettenrolle und Farbband lassen sich dank des großzügig bemessenen Gehäusedeckels einfach und schnell wechseln.

Trotz der geringen Größe des Gehäuses kann der Thermotransferdrucker mit Etikettenrollen bis zu 127 mm (5") und Farbbändern mit 300 m Länge ausgestattet werden. Leerlaufzeiten bedingt durch das Auswechseln des Verbrauchsmaterials werden somit verringert und die Produktivität gesteigert.

### Etikettenspendeeinrichtung

Die Lichtschranke erkennt das Etikett in der Spendeposition und unterbricht den Druckjob. Nach dem Entnehmen des Etiketts von Hand wird automatisch das Nächste gedruckt.

### Schnittstellen

Die PRINTMAX Serie verfügt standardmäßig über einen Serien-, einen Parallel- und einen USB-Anschluss. Um den Drucker in ein Netzwerk zu integrieren, ist optional eine interne Ethernet Karte verfügbar. Damit lässt sich der PRINTMAX praktisch an alle Computersysteme anschließen.



Schnittstellen  
interfaces

### label printer for the BarCon Software System

The ASANUS BarCon software system offers you high-quality instrument and management software which allows you to document processes in CSSD and OR professionally and safely.

The software is divided into two main areas: first, the sterile product management including the implants. The second area comprises the holistic order system and the service recording for each case, cost centre and material type.

In order to support this system, as well as to avoid hardware problems, we ask you to use only the products listed in this catalogue as these are compatible with our system.

### appealing design and compact overall size

- low-cost starter model for smaller printing volumes
- thermal direct or thermal transfer print
- print speed up to 200 mm/s
- print width up to 106.6 mm - serial, parallel and USB port

The PRINTMAX series prints alternatively in thermal direct or thermal transfer mode. The pleasing design inserts itself into different environments. Owing to the amply measured cover label roll and ribbon, it can be changed simply and fast.

Despite the small size of housing the printer can be equipped with label rolls up to 127 mm (5") and ribbons with 300 m length. Idle times caused by replacing the expandable material will be reduced and productivity will be increased.

### label dispenser unit

The light barrier recognises the label in dispensing position and interrupts the print job. After removing the label manually, the next label is printed automatically.

### interfaces

Moreover, the PRINTMAX series is equipped with standard serial, parallel and an USB connection. In order to integrate the printer into a network an internal Ethernet card is optionally available. Thereby the PRINTMAX can be connected to almost all computer systems.



Etikettenspendeeinrichtung  
label dispenser unit

**HWBC45**

**PRINTMAX**  
Etikettendrucker  
label printer



**SWET0110**

Farbband für Etiketten für Siebkorbbe-  
schriftung zu SWET0202  
colour ribbon for labels for basket  
marking SWET0202

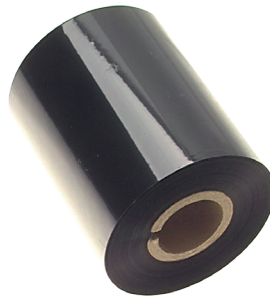

	Rollenkern roll size	Etikettenmenge je Rolle labels per roll	Indikator indicator	
70 x 33 mm	40 mm	1000	-	<b>SWET0202</b>

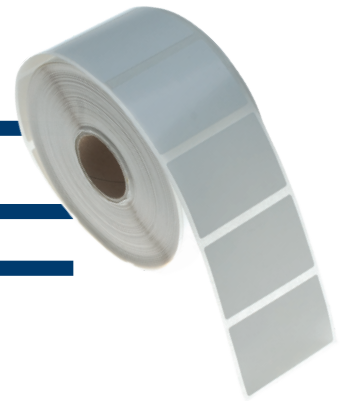

**Permanent Etiketten**

speziell für die Siebkorbbeschriftung

**permanent labels**

special for basket marking

**SWMS002**

Markierungs- und Entsorgungsschilder  
für SWET0202  
labeling marker  
for SWET0202





### mehr Flexibilität - mehr Leistung

- Druckgeschwindigkeit bis zu 200 mm/s - großes Grafikdisplay (vorteilhaft zur Darstellung internationaler Zeichensätze sowie Sonderzeichen) mit 132 x 64 Pixel und weißer Hintergrundbeleuchtung
- standardmäßig integrierte LAN-, USB- sowie serielle und parallele Schnittstelle
- optional WLAN 802.11 b/g Schnittstelle
- neu entwickelte Abschneidevorrichtung
- 2-fach USB Host für den Anschluss einer USB Tastatur und eines Memory Sticks, so wie eines Einschubs für Compact Flash Karten
- optionale Ethernet/LAN Schnittstelle

Die ASANUS PRINTSTAR Serie vereint Flexibilität, Leistung und Zuverlässigkeit zu einer kompakten Technik auf kleinstem Raum, mit der man dank neuesten Technologien auch für zukünftige Anforderungen bestens gerüstet ist. Standardleistungen wie die LAN 802.3 10/100 Schnittstelle oder der 2-fache USB Host für den Anschluss einer USB Tastatur und eines Memory Sticks sind in dieser Druckerserie selbstverständlich.

Darüber hinaus eignet sich die PRINTSTAR Serie wegen des großen Grafikdisplays hervorragend für ein Arbeiten im stand-alone Betrieb. Neben den aktuellen Druckköpfen für den Thermotransfer Druck, werden speziell für den Thermodirekt Druck langlebige Druckköpfe eingesetzt. Für Anwendungen mit extrem feinen Grafiken oder kleinen Schriften, wird ein hochauflösender Druckkopf mit 24 dot/mm (600 dpi) angeboten.

### Stand-Alone Betrieb

Dank einer standardmäßigen Ausstattung mit 2-fach USB Host für den Anschluss einer USB Tastatur und eines Memory Sticks sowie eines Compact Flash Laufwerks ist dieses System hervorragend für den Einsatz im Stand-Alone Betrieb einsetzbar. Mit dem großen Grafikdisplay lassen sich nun Tastatureingaben sowie internationale Zeichensätze und Sonderzeichen komfortabel darstellen.

### leistungsfähige Anschlüsse

Die Drucker verfügen standardmäßig über vier leistungsfähige interne Schnittstellen. Zu paralleler, serieller und USB Schnittstelle ist für den Anschluss im Netzwerk eine interne LAN 802.3 10/100 Schnittstelle dazugekommen. Optional lässt sich für die Datenübertragung per Funk eine WLAN 802.11 b/g Schnittstelle installieren. Des Weiteren ist ein 2-fach USB Host für den Anschluss einer USB Tastatur und eines USB Memory Sticks integriert.

### more flexibility - more efficiency

- print speed up to 200 mm/s - large graphic display (favourable for indication of international character sets as well as special characters) with 132 x 64 pixels and white background lighting
- interfaces by default: serial, parallel, USB, LAN 802.3 10/100
- optional WLAN 802.11 b/g interface
- new developed cutter unit
- USB host for connection of USB keyboard and memory stick as well as a slot for compact flash card
- optional Ethernet/LAN interface

The ASANUS PRINTSTAR series combines flexibility, efficiency and reliability to a compact technology on smallest space. Thanks to its up-to-date technique, the PRINTSTAR is best-prepared for future requirements. It goes without saying that all printers of this series are equipped by default with LAN 802.3 10/100 interface and an USB host to connect USB keyboard and memory stick.

Beyond that the PRINTSTAR series is suitable for working in stand-alone mode owing to the large graphic display. Beside the current printheads for thermal transfer printing we provide long-living printheads particularly for thermal direct printing. For applications with extreme fine graphics or small fonts a high-resolution printhead with 24 dot/mm (600 dpi) is offered.

### stand-alone mode

Thanks to standard equipment with a twofold USB host for connection of an USB keyboard and a memory stick as well as a drive for Compact Flash cards, this printing system is best to use in stand-alone mode. With the large graphic display, keyboard entries as well as international character sets and special characters can be displayed comfortably.

### powerful ports

The printers are equipped with four efficient internal standard interfaces. In addition to a serial, parallel and USB interface an internal LAN 802.3 10/100 interface for network connection was added. For wireless data transmission, the printer can be equipped with a WLAN 802.11 b/g interface optionally. Moreover, an USB host for connection of an USB keyboard and a memory stick is integrated.

**HWBC41**

**PRINTSTAR**  
 mit Abschneidevorrichtung  
 with label rewinder



**SWET0112**

Farbband  
 colour ribbon

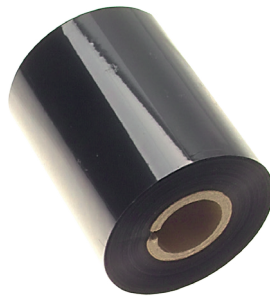

Maße dimension	Rollenkern roll size	Etikettenmenge je Rolle labels per roll	Indikator indicator	
70 mm	50 mm	-	WD/WS	<b>SWET0100</b>
70 mm	70 mm	-	WD/WS	<b>SWET0111</b>

**Produktion Etiketten endlos**  
 speziell für Abschneidevorrichtungen  
**production labels endless**  
 special for label rewinder

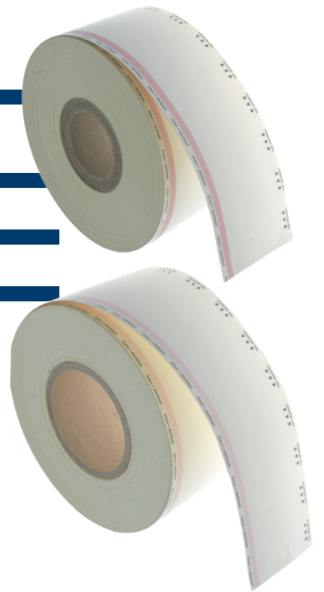

**HWBC43**

**PRINTSTAR**

Etikettendrucker  
label printer



**SWET0112**

Farbband  
colour ribbon



Maße dimension	Rollenkern roll size	Etikettenmenge je Rolle labels per roll	Indikator indicator	
70 x 33 mm	40 mm	2000	WD/WS	<b>SWET0104</b>
70 x 33 mm	76 mm	2000	WD/WS	<b>SWET0107</b>

**Produktion Haft-Etiketten**  
production self-adhesive-labels

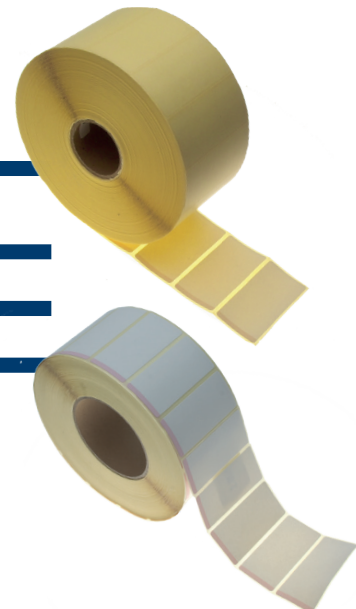



Maße dimension	Rollenkern roll size	Etikettenmenge je Rolle labels per roll	Indikator indicator	
60 x 31 mm	76 mm	1000	WD/WS	<b>SWET0108</b>
60 x 33 mm	40 mm	1000	WD/WS	<b>SWET0108-1</b>

**Produktion Split-Etiketten**  
production split-labels

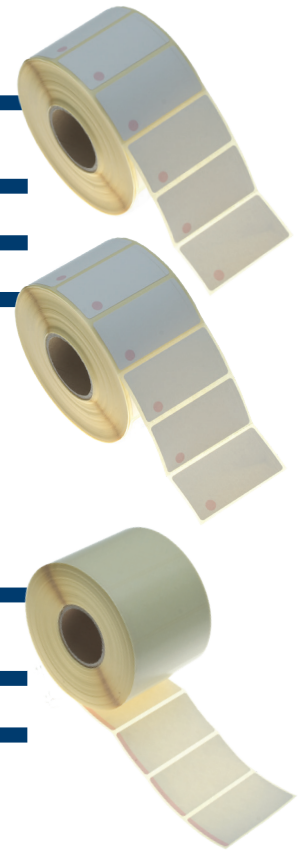

Maße dimension	Rollenkern roll size	Etikettenmenge je Rolle labels per roll	Indikator indicator	
70 x 35 mm	40 mm	1000	WD/WS	<b>SWET0113</b>

**Produktion Sandwich-Etiketten**  
production sandwich-labels

Maße dimension	Rollenkern roll size	Etikettenmenge je Rolle labels per roll	Indikator indicator	
60 x 33 mm	40 mm	1000	WD/WS	<b>SWET0120</b>

**Produktion Haft-Etiketten, rosa**  
production self-adhesive-labels, rose

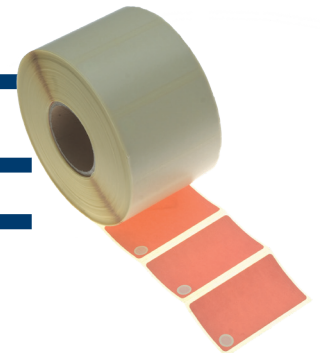

Maße dimension	Rollenkern roll size	Etikettenmenge je Rolle labels per roll	Indikator indicator	
60 x 33 mm	40 mm	1000	WD/WS	<b>SWET0121</b>

**Produktion Haft-Etiketten, gelb**  
production self-adhesive-labels, yellow

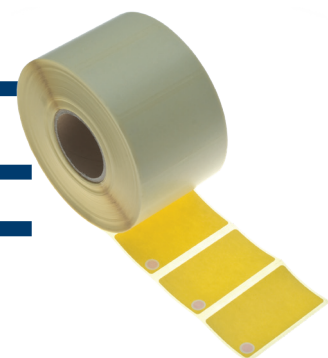



### modularer Aufbau für eine hohe Einsatzvielfalt

- interne Aufwicklung der Etiketten als Standardausrüstung
- große Etikettenrollen bis zu 200 mm Durchmesser
- Druckgeschwindigkeit bis zu 200 mm/s
- einfachste Bedienungs- und Wartungsfähigkeit

Durch die optimale Abstimmung von Transferband, Etiketten und Andruckstärke druckt der ASANUS PROFI 106 auf Typenschilder, Haftetiketten, Papier, Pappe, Textil und Kunststoff. Schnell und einfach erhalten sie passende Etiketten mit einem abriebfesten, witterungs- und chemikalienbeständigen Druckbild. Somit sind eine lebenslange Identifikation Ihres Produktes und die Nachverfolgbarkeit mit Hilfe der Seriennummer sichergestellt. Die Anforderungen einer zuverlässigen Etikettierung sind garantiert. Oberstes Ziel bei der Entwicklung war die einfache und komfortable Bedienung sowie die hohe Zuverlässigkeit auch bei rauen Einsatzbedingungen. Das Gehäuse und die Druckmechanik sind aus hochwertigen Materialien gefertigt und perfekt aufeinander abgestimmt. Jede noch so spezifische Kundenanforderung wird mit der umfangreichen Peripherie und Software umgesetzt.

### Etikettenspendeeinrichtung

Zum Spenden von Etiketten wird zusätzlich eine Spendelichtschranke oder Spendeingänge benötigt. Der Druckvorgang wird nach Abnehmen des Etiketts über die Spendelichtschranke oder über ein externes Signal auf den Spendeingang aktiviert. Das Trägermaterial wird dabei mit der standardmäßigen, internen Aufwickelvorrichtung aufgewickelt.

### Abschneidevorrichtung

Die halbrothierende Abschneidevorrichtung des ASANUS PROFI106 kann Etikettenmaterial bis zu einem Gewicht von ca. 220 g/m<sup>2</sup> schneiden. Das nachrüstbare Messer ermöglicht Einzelschnitt, Intervall- und Endeschnitt. Das Messer kann einfach und schnell mit zwei Zapfen am Drucker aufgesteckt und mit einer Schraube befestigt werden.

### modular structure for high versatility

- internal rewinding of labels as standard equipment
- large label rolls up to a diameter of 200 mm
- print speed up to 200 mm/s
- simplest operating and maintenance

The optimal matching of transfer ribbon, label and pressure power enable the ASANUS PROFI 106 to print onto type plates, adhesive labels, paper, cardboard, textile and plastic. Fast and easily suitable labels with an abrasion, weather and chemical resistant printout can be obtained. A lifelong identification of your product and traceability with the aid of serial numbers is guaranteed. Requirements of reliable labeling are guaranteed. The ultimate ambition with the development was the simple and comfortable handling as well as high reliability - also in harsh environments. Housing and print mechanics are perfectly coordinated and manufactured from high-quality materials. Each specific customer requirement is realised with the extensive periphery and software.

### label dispenser unit

For dispensing of labels an additional dispenser light barrier or dispenser inputs are needed. After removing the label the print order is activated by the dispenser light barrier or by an external signal on the dispenser input. The backing material is rolled up with the internal standard rewinder.

### cutter unit

The half-rotary cutter of the ASANUS PROFI106 series permits fast cutting of different label materials up to a weight of 220 g/m<sup>2</sup>. The refit cutter permits single, interval and final cut. The cutter can be mounted easily and fast with two pins to the printer and fixed with a screw.

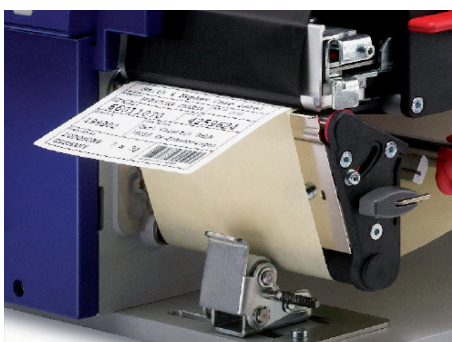

Etikettenspendeeinrichtung  
label dispenser unit



Abschneidevorrichtung  
cutter unit



HWBC44-1

**PROFI106**  
 mit Abschneidevorrichtung  
 with label rewinder



SWET0112

Farbband  
 colour ribbon

Maße dimension	Rollenkern roll size	Etikettenmenge je Rolle labels per roll	Indikator indicator	
70 mm	50 mm	-	WD/WS	<b>SWET0100</b>
70 mm	70 mm	-	WD/WS	<b>SWET0111</b>

**Produktion Etiketten endlos**  
 speziell für Abschneidevorrichtungen  
**production labels endless**  
 special for label rewinder

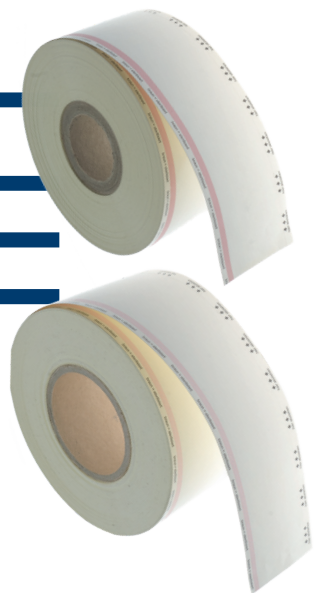

HWBC44

**PROF1106**  
 Etikettendrucker  
 label printer



SWET0112

**Farbband**  
 colour ribbon

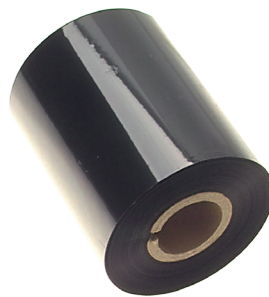

Maße dimension	Rollenkern roll size	Etikettenmenge je Rolle labels per roll	Indikator indicator	
70 x 33 mm	40 mm	2000	WD/WS	<b>SWET0104</b>
70 x 33 mm	76 mm	2000	WD/WS	<b>SWET0107</b>

**Produktion Haft-Etiketten**  
 production self-adhesive-labels

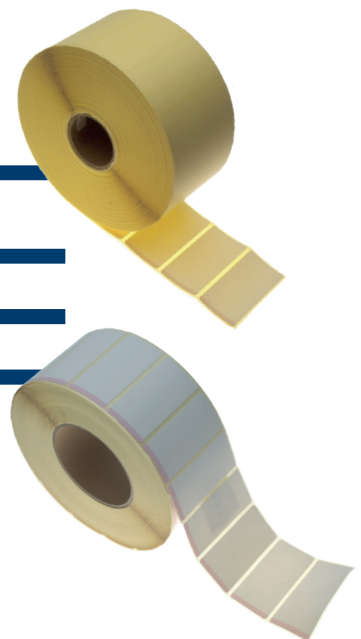

Maße dimension	Rollenkern roll size	Etikettenmenge je Rolle labels per roll	Indikator indicator	
60 x 31 mm	76 mm	1000	WD/WS	<b>SWET0108</b>
60 x 33 mm	40 mm	1000	WD/WS	<b>SWET0108-1</b>

**Produktion Split-Etiketten**  
production split-labels

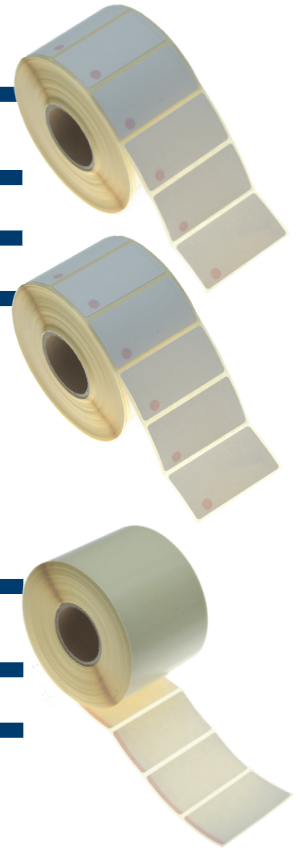

Maße dimension	Rollenkern roll size	Etikettenmenge je Rolle labels per roll	Indikator indicator	
70 x 35 mm	40 mm	1000	WD/WS	<b>SWET0113</b>

**Produktion Sandwich-Etiketten**  
production sandwich-labels

Maße dimension	Rollenkern roll size	Etikettenmenge je Rolle labels per roll	Indikator indicator	
60 x 33 mm	40 mm	1000	WD/WS	<b>SWET0120</b>

**Produktion Haft-Etiketten, rosa**  
production self-adhesive-labels, rosa

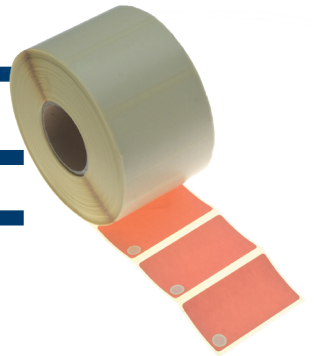

Maße dimension	Rollenkern roll size	Etikettenmenge je Rolle labels per roll	Indikator indicator	
60 x 33 mm	40 mm	1000	WD/WS	<b>SWET0121</b>

**Produktion Haft-Etiketten, gelb**  
production self-adhesive-labels, yellow

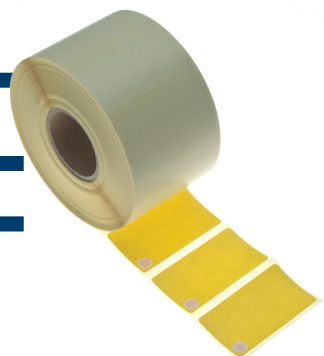

# Scanner scanner



	Bezeichnung description
<b>HWBC13</b>	Handscanner mit Kabel, IP30 geschützt mobile scanner with cable, IP30 protected

Scanner  
scanner



	Bezeichnung description
<b>HWBC17</b>	mobiler Scanner, IP42 geschützt mobile scanner, IP42 protected

Scanner  
scanner



	Bezeichnung description
<b>HWBC25</b>	mobiler Scanner, IP65 geschützt mobile scanner, IP65 protected

Scanner  
scanner

## ergonomische Beleuchtungsmethoden

Das ASANUS Kombi System für Beleuchtungsmethoden und Webcam bieten dem Anwender folgende Vorteile:

- energieeffizient
- leicht und individuell positionierbar
- besonders kühl bleibender Leuchtkopf
- hochwertige Bildaufnahmen



**HWBC110**

### Stativleuchten klein

technische Daten:

- Anschlusswerte: 220-240V; 50 Hz  
 Technik: schaltbar  
 Befestigung: kombinierbar  
 Gelenkentlastung: Friktion

### tripod lamps small

technical information:

- connection: 220-240V; 50 Hz  
 technics: shifttable  
 fixing: combined  
 joint relief: friction

**HWBC112**

### Tischfuß table base



**HWBC113**

### Tischklemme table clamp



## ergonomically lightning methods

The ASANUS Combi System of lightning methods and Webcam offers the user following benefits:

- energy-efficient
- easily and individually positioned
- constant cool light head
- pictures in high quality

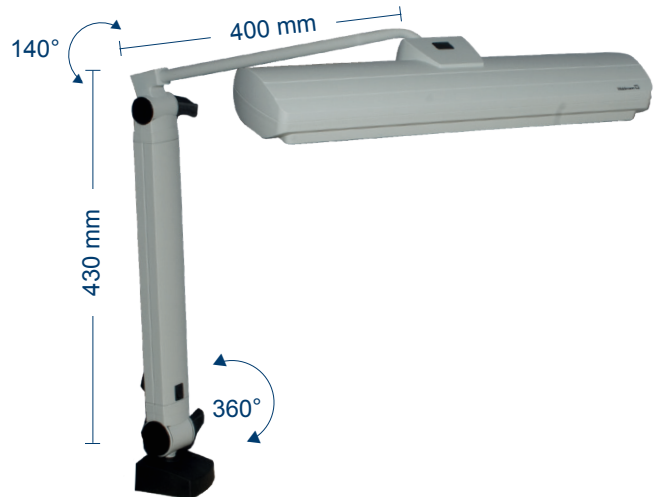

**HWBC110**

### Stativleuchten groß

technische Daten:

- Anschlusswerte: 220-240V; 50/60 Hz  
 Technik: schaltbar  
 Befestigung: kombinierbar  
 Gelenkentlastung: Feder

### tripod lamps large

technical information:

- connection: 220-240V; 50/60 Hz  
 technics: shifttable  
 fixing: combined  
 joint relief: clip

**HWBC80**

### Webcam

technische Daten:

- Optik: Carl Zeiss mit Autofokus  
 Auflösung: Fotos mit bis zu 8 MP / 720p Breitbildmodus  
 Befestigung: Universalhalterung

### webcam

technical information:

- definition: Carl Zeiss with autofocus  
 optics: up to 8-MP photos / 720p wide screen mode  
 fixing: universal clip



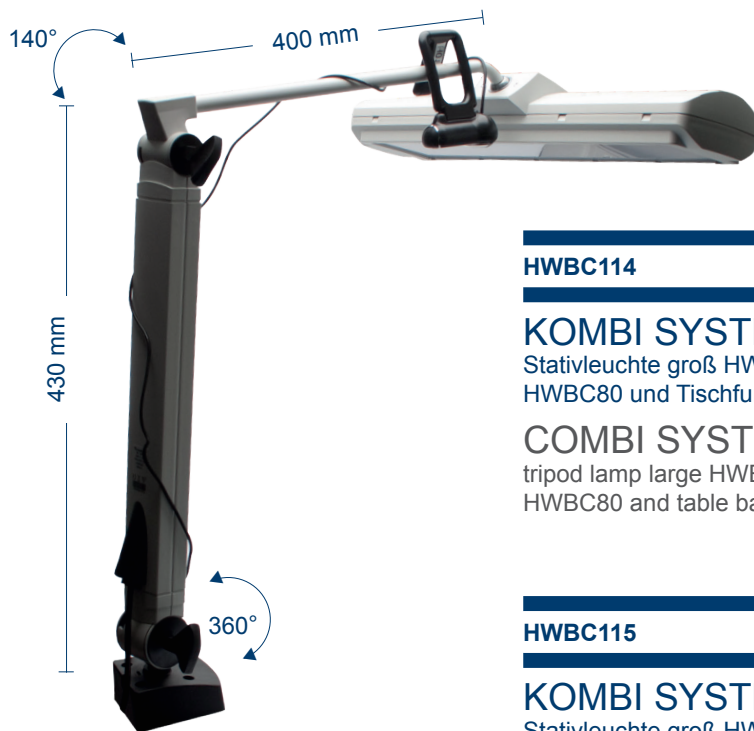

**HWBC114**

### KOMBI SYSTEM GROSS

Stativleuchte groß HWBC111 mit Webcam  
HWBC80 und Tischfuß HWBC112

### COMBI SYSTEM LARGE

tripod lamp large HWBC111 with webcam  
HWBC80 and table base HWBC112

**HWBC115**

### KOMBI SYSTEM GROSS

Stativleuchte groß HWBC111 mit Webcam  
HWBC80 und Tischfuß HWBC113

### COMBI SYSTEM LARGE

tripod lamp large HWBC111 with webcam  
HWBC80 and table base HWBC113

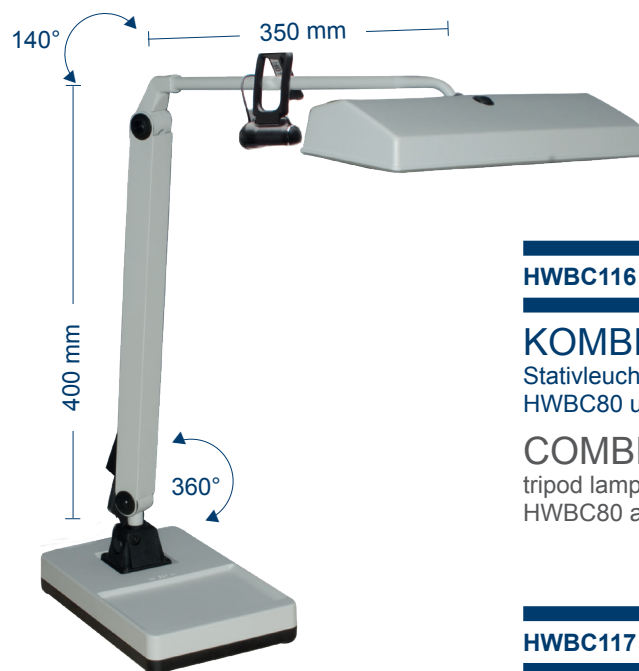

**HWBC116**

### KOMBI SYSTEM KLEIN

Stativleuchte klein HWBC110 mit Webcam  
HWBC80 und Tischfuß HWBC112

### COMBI SYSTEM SMALL

tripod lamp small HWBC110 with webcam  
HWBC80 and table base HWBC112

**HWBC117**

### KOMBI SYSTEM KLEIN

Stativleuchte klein HWBC110 mit Webcam  
HWBC80 und Tischfuß HWBC113

### COMBI SYSTEM SMALL

tripod lamp small HWBC110 with webcam  
HWBC80 and table base HWBC113



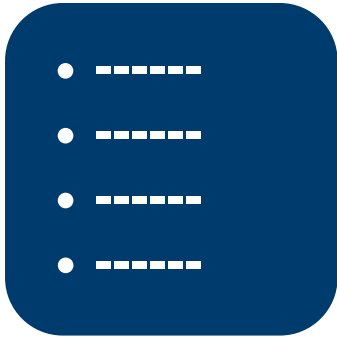

## Artikelnummern Index item number index

Index ..... 132

index ..... 132



Seite page	Seite page	Seite page	Seite page	Seite page
CT5300G.....41	CT5321B.....34	CT5515R.....14	CT5601G.....16	CT5674BY.....28
CT5300R.....41	CT5321G.....34	CT5515S.....14	CT5601R.....16	CT5674PA.....28
CT5300S.....41	CT5321R.....34	CT5515Y.....14	CT5601S.....16	CT5674PB.....28
CT5300VA.....41	CT5321S.....34	CT5517A.....14	CT5601Y.....16	CT5674PG.....28
CT5300VB.....41	CT5321Y.....34	CT5517B.....14	CT5603A.....16	CT5674PR.....28
CT5300VG.....41	CT5322A.....34	CT5517G.....14	CT5603B.....16	CT5674PS.....28
CT5300VR.....41	CT5322B.....34	CT5517R.....14	CT5603G.....16	CT5674PY.....28
CT5300VS.....41	CT5322G.....34	CT5517S.....14	CT5603R.....16	CT5674VA.....28
CT5300VY.....41	CT5322R.....34	CT5517Y.....14	CT5603S.....16	CT5674VB.....28
CT5300Y.....41	CT5322S.....34	CT5519A.....14	CT5603Y.....16	CT5674VG.....28
CT5301A.....40	CT5322Y.....34	CT5519B.....14	CT5605A.....16	CT5674VR.....28
CT5301B.....40	CT5323A.....34	CT5519G.....14	CT5605B.....16	CT5674VS.....28
CT5301G.....40	CT5323B.....34	CT5519R.....14	CT5605G.....16	CT5674VY.....28
CT5301R.....40	CT5323G.....34	CT5519S.....14	CT5605R.....16	CT5701A.....18
CT5301S.....40	CT5323R.....34	CT5519Y.....14	CT5605S.....16	CT5701B.....18
CT5301Y.....40	CT5323S.....34	CT5550.....15, 27	CT5605Y.....16	CT5701G.....18
CT5302A.....40	CT5323Y.....34	CT5551.....15, 27	CT5611A.....16	CT5701R.....18
CT5302B.....40	CT5324.....35	CT5552.....15, 27	CT5611B.....16	CT5701S.....18
CT5302G.....40	CT5325.....35	CT5553.....15, 27	CT5611G.....16	CT5701Y.....18
CT5302R.....40	CT5326.....35	CT5554.....15, 27	CT5611R.....16	CT5703A.....18
CT5302S.....40	CT5501A.....14	CT5556.....15	CT5611S.....16	CT5703B.....18
CT5302Y.....40	CT5501B.....14	CT5556.....15	CT5611Y.....16	CT5703G.....18
CT5303A.....40	CT5501G.....14	CT5562.....15	CT5613A.....16	CT5703R.....18
CT5303B.....40	CT5501R.....14	CT5563.....15	CT5613B.....16	CT5703S.....18
CT5303G.....40	CT5501S.....14	CT5564.....15	CT5613G.....16	CT5703Y.....18
CT5303R.....40	CT5501Y.....14	CT5572A.....15	CT5613R.....16	CT5705A.....18
CT5303S.....40	CT5503A.....14	CT5572B.....15	CT5613S.....16	CT5705B.....18
CT5303Y.....40	CT5503B.....14	CT5572G.....15	CT5613Y.....16	CT5705G.....18
CT5304A.....40	CT5503G.....14	CT5572R.....15	CT5615A.....16	CT5705R.....18
CT5304B.....40	CT5503R.....14	CT5572S.....15	CT5615B.....16	CT5705S.....18
CT5304G.....40	CT5503S.....14	CT5572Y.....15	CT5615G.....16	CT5705Y.....18
CT5304R.....40	CT5503Y.....14	CT5573A.....15, 27	CT5615R.....16	CT5707A.....18
CT5304S.....40	CT5505A.....14	CT5573B.....15, 27	CT5615S.....16	CT5707B.....18
CT5304Y.....40	CT5505B.....14	CT5573G.....15, 27	CT5615Y.....16	CT5707G.....18
CT5305A.....40	CT5505G.....14	CT5573R.....15, 27	CT5650.....17, 28	CT5707R.....18
CT5305B.....40	CT5505R.....14	CT5573S.....15, 27	CT5651.....17, 28	CT5707S.....18
CT5305G.....40	CT5505S.....14	CT5573Y.....15, 27	CT5652.....17, 28	CT5707Y.....18
CT5305R.....40	CT5505Y.....14	CT5574AA.....27	CT5660.....17	CT5709A.....18
CT5305S.....40	CT5507A.....14	CT5574AB.....27	CT5661.....17	CT5709B.....18
CT5305Y.....40	CT5507B.....14	CT5574AG.....27	CT5662.....17	CT5709G.....18
CT5306A.....40	CT5507G.....14	CT5574AR.....27	CT5670A.....17	CT5709R.....18
CT5306B.....40	CT5507R.....14	CT5574AS.....27	CT5670B.....17	CT5709S.....18
CT5306G.....40	CT5507S.....14	CT5574AS-1.....26	CT5670G.....17	CT5709Y.....18
CT5306R.....40	CT5507Y.....14	CT5574AY.....27	CT5670R.....17	CT5711A.....18
CT5306S.....40	CT5509A.....14	CT5574BA.....27	CT5670S.....17	CT5711B.....18
CT5306Y.....40	CT5509B.....14	CT5574BB.....27	CT5670Y.....17	CT5711G.....18
CT5311.....40, 41	CT5509G.....14	CT5574BG.....27	CT5673A.....17, 28	CT5711R.....18
CT5312.....40, 41	CT5509R.....14	CT5574BR.....27	CT5673B.....17, 28	CT5711S.....18
CT5313.....40, 41	CT5509S.....14	CT5574BS.....27	CT5673G.....17, 28	CT5711Y.....18
CT5314.....40, 41	CT5509Y.....14	CT5574BS-1.....26	CT5673R.....17, 28	CT5713A.....18
CT5315.....40, 41	CT5511A.....14	CT5574BY.....27	CT5673S.....17, 28	CT5713B.....18
CT5316.....40, 41	CT5511B.....14	CT5574PA.....27	CT5673Y.....17, 28	CT5713G.....18
CT5320A.....35	CT5511G.....14	CT5574PB.....27	CT5674AA.....28	CT5713R.....18
CT5320B.....35	CT5511R.....14	CT5574PG.....27	CT5674AB.....28	CT5713S.....18
CT5320G.....35	CT5511S.....14	CT5574PR.....27	CT5674AG.....28	CT5713Y.....18
CT5320R.....35	CT5511Y.....14	CT5574PS.....27	CT5674AR.....28	CT5715A.....18
CT5320S.....35	CT5513A.....14	CT5574PY.....27	CT5674AS.....28	CT5715B.....18
CT5320VA.....35	CT5513B.....14	CT5574VA.....27	CT5674AS-1.....26	CT5715G.....18
CT5320VB.....35	CT5513G.....14	CT5574VB.....27	CT5674AY.....28	CT5715R.....18
CT5320VG.....35	CT5513R.....14	CT5574VG.....27	CT5674BA.....28	CT5715S.....18
CT5320VR.....35	CT5513S.....14	CT5574VR.....27	CT5674BB.....28	CT5715Y.....18
CT5320VS.....35	CT5513Y.....14	CT5574VS.....27	CT5674BG.....28	CT5717A.....18
CT5320VY.....35	CT5515A.....14	CT5574VY.....27	CT5674BR.....28	CT5717B.....18
CT5320Y.....35	CT5515B.....14	CT5601A.....16	CT5674BS.....28	CT5717G.....18
CT5321A.....34	CT5515G.....14	CT5601B.....16	CT5674BS-1.....26	CT5717R.....18

# Index index

Seite page	Seite page	Seite page	Seite page	Seite page
CT5717S.....18	CT5802Y.....20	CT5974AA.....31	HWBC17.....128	SL0148.....110
CT5717Y.....18	CT5806A.....20	CT5974AB.....31	HWBC25.....128	SL0275.....109
CT5719A.....18	CT5806B.....20	CT5974AG.....31	HWBC41.....121	SL0980.....108
CT5719B.....18	CT5806G.....20	CT5974AR.....31	HWBC43.....122	SL0981.....108
CT5719G.....18	CT5806R.....20	CT5974AS.....31	HWBC44.....126	SL0990.....108
CT5719R.....18	CT5806S.....20	CT5974AS-1.....26	HWBC44-1.....125	SL0991.....108
CT5719S.....18	CT5806Y.....20	CT5974AY.....31	HWBC45.....119	SL0992.....108
CT5719Y.....18	CT5850.....21, 30	CT5974BA.....31	HWBC80.....129	SL0993.....108
CT5750.....19, 29	CT5851.....21, 30	CT5974BB.....31	HWBC110.....129	SL1002.....108
CT5751.....19, 29	CT5860.....21	CT5974BG.....31	HWBC112.....129	SL1004.....108
CT5752.....19, 29	CT5861.....21	CT5974BR.....31	HWBC113.....129	SL1006.....108
CT5753.....19, 29	CT5870A.....21	CT5974BS.....31	HWBC114.....130	SL1008.....108
CT5754.....19, 29	CT5870B.....21	CT5974BS-1.....26	HWBC115.....130	SL1010.....108
CT5760.....19	CT5870G.....21	CT5974BY.....31	HWBC116.....130	SL1020.....110
CT5761.....19	CT5870R.....21	CT5974PA.....31	HWBC117.....130	SL1021.....110
CT5762.....19	CT5870S.....21	CT5974PB.....31		SL1022.....110
CT5763.....19	CT5870Y.....21	CT5974PG.....31	<b>N</b>	SL1023.....110
CT5764.....19	CT5874AA.....30	CT5974PR.....31	ND0820.....106	SL1024.....110
CT5770A.....19	CT5874AB.....30	CT5974PS.....31	ND0830.....106	SL1025.....110
CT5770B.....19	CT5874AG.....30	CT5974PY.....31	ND0840.....106	SL1026.....110
CT5770G.....19	CT5874AR.....30	CT5974VA.....31	ND0850.....106	SL1105.....111
CT5770R.....19	CT5874AS.....30	CT5974VB.....31	ND0851.....106	SL1107.....111
CT5770S.....19	CT5874AS-1.....26	CT5974VG.....31	ND0852.....106	SL1110.....111
CT5770Y.....19	CT5874AY.....30	CT5974VR.....31	ND0880.....107	SL1111.....111
CT5773A.....19, 29	CT5874BA.....30	CT5974VS.....31	ND0890.....107	SL1114.....111
CT5773B.....19, 29	CT5874BB.....30	CT5974VY.....31		SL1119.....111
CT5773G.....19, 29	CT5874BG.....30	CT5991A.....48	<b>O</b>	SL1120.....111
CT5773R.....19, 29	CT5874BR.....30	CT5991B.....48	OL5000.....102	SL1130.....111
CT5773S.....19, 29	CT5874BS.....30	CT5991G.....48		SL1145.....111
CT5773Y.....19, 29	CT5874BS-1.....26	CT5991R.....48	<b>S</b>	SL1160.....111
CT5774AA.....29	CT5874BY.....30	CT5991S.....48	SL0050.....113	SL1180.....111
CT5774AB.....29	CT5874PA.....30	CT5991Y.....48	SL0051.....113	ST0007.....113
CT5774AG.....29	CT5874PB.....30	CT9010.....89	SL0052.....113	ST0010.....83
CT5774AR.....29	CT5874PG.....30	CT9010A.....89	SL0053.....113	ST0011.....83
CT5774AS.....29	CT5874PR.....30	CT9010B.....89	SL0054.....113	ST0012.....83
CT5774AS-1.....26	CT5874PS.....30	CT9010G.....89	SL0055.....113	ST0013.....83
CT5774AY.....29	CT5874PY.....30	CT9010R.....89	SL0080.....109	ST0014.....83
CT5774BA.....29	CT5874VA.....30	CT9010S.....89	SL0090.....108	ST0015.....83
CT5774BB.....29	CT5874VB.....30	CT9010Y.....89	SL0093.....108	ST0016.....83
CT5774BG.....29	CT5874VG.....30		SL0094.....108	ST0017.....83
CT5774BR.....29	CT5874VR.....30	<b>D</b>	SL0095.....111	ST0090.....109
CT5774BS.....29	CT5874VS.....30	DSP023.....104	SL0096.....111	ST0091.....109
CT5774BS-1.....26	CT5874VY.....30	DSP024.....104	SL0099.....111	ST0092.....109
CT5774BY.....29	CT5902A.....22	DSP101.....104	SL0100.....111	ST0093.....109
CT5774PA.....29	CT5902B.....22	DSP102.....104	SL0101.....111	ST0094.....109
CT5774PB.....29	CT5902G.....22	DSP103.....104	SL0102.....111	ST0095.....109
CT5774PG.....29	CT5902R.....22	DSP104.....104	SL0107.....109	ST0096.....109
CT5774PR.....29	CT5902S.....22	DSP105.....104	SL0123.....109	ST0101.....105
CT5774PS.....29	CT5902Y.....22	DSP106.....104	SL0125.....109	ST0103.....105
CT5774PY.....29	CT5906A.....22	DSP107.....104	SL0130.....110	ST0104.....105
CT5774VA.....29	CT5906B.....22	DSP108.....104	SL0131.....110	ST0110.....63
CT5774VB.....29	CT5906G.....22	DSP121.....104	SL0132.....110	ST0111.....63
CT5774VG.....29	CT5906R.....22	DSP122.....104	SL0133.....110	ST0112.....63
CT5774VR.....29	CT5906S.....22	DSP123.....104	SL0134.....110	ST0113.....63
CT5774VS.....29	CT5906Y.....22	DSP124.....104	SL0135.....110	ST0114.....63
CT5774VY.....29	CT5950.....23, 31	DSP125.....104	SL0136.....110	ST0115.....63
CT5775A.....26	CT5951.....23, 31	DSP126.....104	SL0137.....110	ST0116.....63
CT5775B.....26	CT5960.....23	DSP127.....104	SL0138.....110	ST0117.....63
CT5775P.....26	CT5961.....23	DSP128.....104	SL0139.....110	ST0120.....63
CT5775V.....26	CT5970A.....23	DSP129.....104	SL0140.....110	ST0121.....63
CT5802A.....20	CT5970B.....23	DSP130.....104	SL0141.....110	ST0122.....63
CT5802B.....20	CT5970G.....23		SL0143.....110	ST0123.....63
CT5802G.....20	CT5970R.....23	<b>H</b>	SL0145.....110	ST0124.....63
CT5802R.....20	CT5970S.....23	HWBC13.....128	SL0146.....110	ST0125.....63
CT5802S.....20	CT5970Y.....23			

Seite page	Seite page	Seite page	Seite page	Seite page
ST0126.....63	ST0196.....67	ST0370.....78	ST4911.....61	ST5080.....57
ST0127.....63	ST0197.....67	ST0371.....79	ST4912.....61	ST5082.....57
ST0130.....64	ST0198.....67	ST0372.....79	ST4913.....61	ST5084.....58
ST0131.....64	ST0199.....67	ST0373.....79	ST4914.....62	ST5086.....58
ST0132.....64	ST0200.....67	ST0374.....79	ST4915.....62	ST5110.....53
ST0133.....64	ST0201.....67	ST0375.....79	ST4916.....62	ST5251.....69
ST0134.....64	ST0202.....67	ST0376.....79	ST4917.....62	ST5253.....69
ST0135.....64	ST0203.....67	ST0377.....79	ST5006.....53	ST5254.....97
ST0136.....64	ST0204.....67	ST0378.....79	ST5006-1.....53	ST5255.....97
ST0137.....64	ST0205.....67	ST0379.....79	ST5007.....53	ST5256.....93
ST0140.....64	ST0206.....68	ST0500.....71	ST5008.....53	ST5257.....69
ST0141.....64	ST0280.....70	ST0507.....71	ST5009.....53	ST5258.....69
ST0142.....64	ST0281.....70	ST0508.....71	ST5010.....53	ST5259.....97
ST0143.....64	ST0282.....70	ST0510.....71	ST5011.....53	ST5260.....97
ST0144.....64	ST0283.....70	ST4850.....54	ST5011-1.....53	ST5261.....93
ST0145.....64	ST0284.....70	ST4851.....54	ST5012.....53	ST5370.....51
ST0146.....64	ST0285.....70	ST4852.....54	ST5014-01.....54	ST5371.....51
ST0147.....64	ST0286.....70	ST4853.....54	ST5014-02.....54	ST5372.....51
ST0150.....65	ST0287.....70	ST4854.....54	ST5014-03.....54	ST5373.....51
ST0151.....65	ST0288.....70	ST4855.....54	ST5014-04.....54	ST5374.....93
ST0152.....65	ST0289.....70	ST4856.....54	ST5014-05.....54	ST5381.....69
ST0152-1.....65	ST0290.....70	ST4857.....54	ST5021.....53	ST5383.....69
ST0153.....65	ST0291.....70	ST4858.....54	ST5022.....53	ST5386.....95
ST0154.....65	ST0292.....70	ST4859.....54	ST5023.....53	ST5391.....97
ST0155.....66	ST0293.....70	ST4860.....54	ST5024.....53	ST5399.....93
ST0156.....66	ST0294.....70	ST4861.....54	ST5025.....53	ST5542.....94
ST0157.....66	ST0295.....70	ST4862.....54	ST5026.....53	ST5543.....94
ST0158.....66	ST0296.....70	ST4863.....54	ST5027.....53	ST5579.....50
ST0159.....66	ST0297.....70	ST4864.....54	ST5028.....53	ST5580.....50
ST0160.....66	ST0298.....70	ST4865.....54	ST5029.....53	ST5581.....50
ST0161.....66	ST0330.....76	ST4866.....54	ST5030.....53	ST5582.....50
ST0162.....66	ST0331.....76	ST4867.....54	ST5031.....53	ST5583.....50
ST0163.....66	ST0337.....76	ST4877.....54	ST5032.....53	ST5584.....52
ST0164.....66	ST0338.....76	ST4878.....54	ST5033.....53	ST5585.....52
ST0165.....66	ST0339.....76	ST4879.....54	ST5034.....53	ST5586.....52
ST0166.....66	ST0340.....76	ST4880.....54	ST5035.....53	ST5587.....52
ST0167.....66	ST0341.....75	ST4881.....54	ST5036.....53	ST5590.....95
ST0168.....66	ST0342.....75	ST4882.....54	ST5037.....53	ST5591.....96
ST0169.....66	ST0343.....75	ST4883.....54	ST5038.....53	ST5592.....96
ST0170.....67	ST0344.....75	ST4885.....55	ST5040.....53	ST5593.....93
ST0171.....67	ST0345.....75	ST4886.....55	ST5041.....53	ST5595.....93
ST0172.....67	ST0346.....75	ST4887.....55	ST5042.....53	ST5596.....93
ST0173.....67	ST0347.....75	ST4888.....55	ST5043.....53	ST5597.....93
ST0174.....67	ST0348.....75	ST4889.....55	ST5044.....53	ST5598.....93
ST0175.....67	ST0349.....75	ST4890.....55	ST5045.....53	ST5599.....93
ST0176.....67	ST0350.....75	ST4891.....55	ST5046.....53	ST5599-1.....93
ST0177.....67	ST0351.....76	ST4892.....55	ST5047.....53	ST5640.....94
ST0178.....67	ST0352.....76	ST4893.....55	ST5048.....53	ST5641.....94
ST0179.....67	ST0353.....76	ST4894.....55	ST5055.....54	ST5642.....94
ST0180.....67	ST0354.....76	ST4895.....55	ST5056.....54	ST5643.....94
ST0181.....67	ST0355.....76	ST4896.....55	ST5057.....54	ST5644.....94
ST0182.....67	ST0356.....76	ST4897.....57	ST5060.....56	ST5645.....94
ST0183.....67	ST0357.....76	ST4898.....57	ST5061.....56	ST5679.....50
ST0184.....67	ST0358.....76	ST4899.....58	ST5062.....56	ST5680.....50
ST0185.....67	ST0359.....76	ST4900.....58	ST5063.....56	ST5681.....50
ST0186.....67	ST0360.....76	ST4901.....59	ST5064.....56	ST5682.....50
ST0187.....67	ST0361.....76	ST4902.....59	ST5065.....56	ST5683.....50
ST0188.....67	ST0362.....78	ST4903.....59	ST5066.....56	ST5684.....52
ST0189.....67	ST0363.....78	ST4904.....59	ST5067.....56	ST5685.....52
ST0190.....67	ST0364.....78	ST4905.....59	ST5070.....56	ST5686.....52
ST0191.....67	ST0365.....78	ST4906.....60	ST5071.....56	ST5687.....52
ST0192.....67	ST0366.....78	ST4907.....60	ST5072.....56	ST5690.....95
ST0193.....67	ST0367.....78	ST4908.....60	ST5073.....56	ST5691.....96
ST0194.....67	ST0368.....78	ST4909.....60	ST5075.....54	ST5693.....96
ST0195.....67	ST0369.....78	ST4910.....61	ST5076.....54	ST5742.....94

# Index

## index

Seite page	Seite page	Seite page			
ST5743.....	94	ST5932.....	100	ZB9003.....	102
ST5747.....	94	ST5933.....	100	ZB9004.....	102
ST5748.....	94	ST5934.....	100	ZB9004-1.....	102
ST5779.....	50	ST5935.....	100	ZB9005.....	102
ST5780.....	50	ST5950A.....	86	ZB9006.....	102
ST5781.....	50	ST5950B.....	86	ZB9007.....	102
ST5782.....	50	ST5950G.....	86	ZB9008.....	102
ST5783.....	50	ST5950R.....	86	ZB9009.....	102
ST5784.....	50	ST5950S.....	86	ZB9010A.....	89
ST5785.....	50	ST5950Y.....	86	ZB9010B.....	89
ST5786.....	50	ST5955A.....	86	ZB9010G.....	89
ST5787.....	50	ST5955B.....	86	ZB9010R.....	89
ST5789.....	50	ST5955G.....	86	ZB9010S.....	89
ST5790.....	95	ST5955R.....	86	ZB9010Y.....	89
ST5791.....	97	ST5955S.....	86	ZB9015.....	88
ST5792.....	96	ST5955Y.....	86	ZB9016.....	87
ST5814.....	52	ST5960A.....	86	ZB9020.....	87
ST5815.....	52	ST5960B.....	86	ZB9021.....	87
ST5816.....	52	ST5960G.....	86	ZB9022.....	87
ST5817.....	52	ST5960R.....	86	ZB9025.....	99
ST5818.....	52	ST5960S.....	86	ZB9026.....	99
ST5819.....	52	ST5960Y.....	86	ZB9027.....	99
ST5820.....	52	ST5962.....	51	ZB9028.....	99
ST5821.....	52	ST5963.....	51	ZB9060.....	86
ST5871.....	51	ST5964.....	51	ZB9062.....	86
ST5872.....	51	ST5965.....	51	ZB9066.....	90
ST5873.....	51	ST5969.....	98	ZB9080.....	92
ST5874.....	51	ST5970.....	98	ZB9081.....	93
ST5875.....	94	ST5972.....	98	ZB9082.....	93
ST5875-1.....	94	ST5973.....	98	ZB9085.....	87
ST5876.....	95	ST5974.....	98	ZB9090.....	92
ST5877.....	95	ST5975.....	98	ZB9091.....	92
ST5878.....	96	ST5980.....	72	ZB9092.....	92
ST5879.....	97	ST5981.....	72	ZB9094.....	90
ST5880.....	95	ST5982.....	73	ZB9095.....	90
ST5881.....	95	ST5983.....	74	ZB9096.....	91
ST5882.....	95	ST5985.....	98	ZB9097.....	91
ST5883.....	93	ST5986.....	98	ZB9098.....	91
ST5890.....	77	ST5987.....	98	ZB9099.....	91
ST5891.....	77	ST5988.....	98	ZB9100.....	90
ST5892.....	77	ST5989.....	98	ZB9103.....	92
ST5893.....	77			ZB9104.....	92
ST5894.....	77	SWET0100....	121, 125	ZB9105.....	92
ST5895.....	77	SWET0104....	122, 126	ZB9106.....	92
ST5896.....	77	SWET0107....	122, 126	ZB9200.....	103
ST5898.....	77	SWET0108....	123, 127	ZB9201.....	103
ST5899.....	77	SWET0108-1..	123, 127		
ST5900.....	77	SWET0110.....	119		
ST5901.....	77	SWET0111....	121, 125		
ST5902.....	77	SWET0112.....	121,		
ST5903.....	77		122, 125, 126		
ST5904.....	77	SWET0113....	123, 127		
ST5905.....	77	SWET0120....	123, 127		
ST5913.....	98	SWET0121....	123, 127		
ST5914.....	87	SWET0202.....	119		
ST5915.....	100				
ST5916.....	101	SWMS002.....	119		
ST5917.....	101				
ST5918.....	101	<b>Z</b>			
ST5919.....	101	ZB1010.....	88		
ST5921.....	101	ZB1012.....	88		
ST5922.....	101	ZB9000.....	102		
ST5923.....	101	ZB9001.....	102		
ST5930.....	100	ZB9002.....	102		
ST5931.....	100	ZB9002-1.....	102		















ASANUS Medizintechnik GmbH  
take off Gewerbepark 2  
78579 Neuhausen ob Eck / Tuttlingen  
Germany  
Tel. +49 7467 - 94 74-0  
Fax +49 7467 - 94 74-50  
info@asanus.de  
www.asanus.de

Artikelnummer/item number: \*FLCO  
revision: 201808/1.0

Technische Änderungen vorbehalten. Dieser Prospekt darf ausschließlich zur  
Anbietung und dem An- und Verkauf unserer Erzeugnisse dienen. Nachdruck,  
auch auszugsweise, verboten. Bei Missbrauch behalten wir uns Rücknahme  
der Kataloge und Preislisten sowie Regressmaßnahmen vor.

All rights reserved. Technical alterations are possible. This leaflet may be used  
for no other purposes than offering, buying and selling of our products. No part  
may be copied or reproduced in any form. In the case of misuse we retain the  
rights to recall our catalogues and pricelists and to take legal actions.